

1 ch DC/DC Converter IC with PFM/PWM Synchronous Rectification

Description

The MB39C006A is a current mode type 1-channel DC/DC converter IC built-in switching FET, synchronous rectification, and down conversion support. The device is integrated with a switching FET, oscillator, error amplifier, PFM/PWM control circuit, reference voltage source, and POWERGOOD circuit.

External inductor and decoupling capacitor are needed only for the external component.

MB39C006A is small, achieve a highly effective DC/DC converter in the full load range, this is suitable as the built-in power supply for handheld equipment such as mobile phone/PDA, DVDs, and HDDs.

Features

- High efficiency : 96% (Max)
- Low current consumption : 30 μ A (at PFM)
- Output current (DC/DC) : 800 mA (Max)
- Input voltage range : 2.5 V to 5.5 V
- Operating frequency : 2.0/3.2 MHz (Typ)
- Built-in PWM operation fixed function
- No flyback diode needed
- Low dropout operation : For 100% on duty
- Built-in high-precision reference voltage generator : 1.20 V \pm 2%
- Consumption current in shutdown mode : 1 μ A or less
- Built-in switching FET : P-ch MOS 0.3 Ω (Typ) N-ch MOS 0.2 Ω (Typ)
- High speed for input and load transient response in the current mode
- Over temperature protection
- Packaged in a compact package : SON10

Applications

- Flash ROMs
- MP3 players
- Electronic dictionary devices
- Surveillance cameras
- Portable GPS navigators
- Mobile phones etc.

Contents

Description 1

Features 1

Applications 1

Contents 2

1. Pin Assignment 3

2. Pin Descriptions 3

3. I/O Pin Equivalent Circuit Diagram 4

4. Block Diagram 5

5. Function of Each Block 6

6. Absolute Maximum Ratings 8

7. Recommended Operating Conditions 9

8. Electrical Characteristics 10

9. Test Circuit for Measuring Typical Operating Characteristics 12

10. Application Notes 13

 10.1 Selection of components 13

 10.2 Output voltage setting 13

 10.3 About conversion efficiency 14

 10.4 Power dissipation and heat considerations 15

 10.5 Transient response 15

 10.6 Board layout, design example 15

11. Example of Standard Operation Characteristics 17

12. Application Circuit Examples 31

13. Usage Precautions 33

14. Ordering Information 33

15. RoHS Compliance Information 33

16. Package Dimension 34

Document History 35

Sales, Solutions, and Legal Information 36

1. Pin Assignment

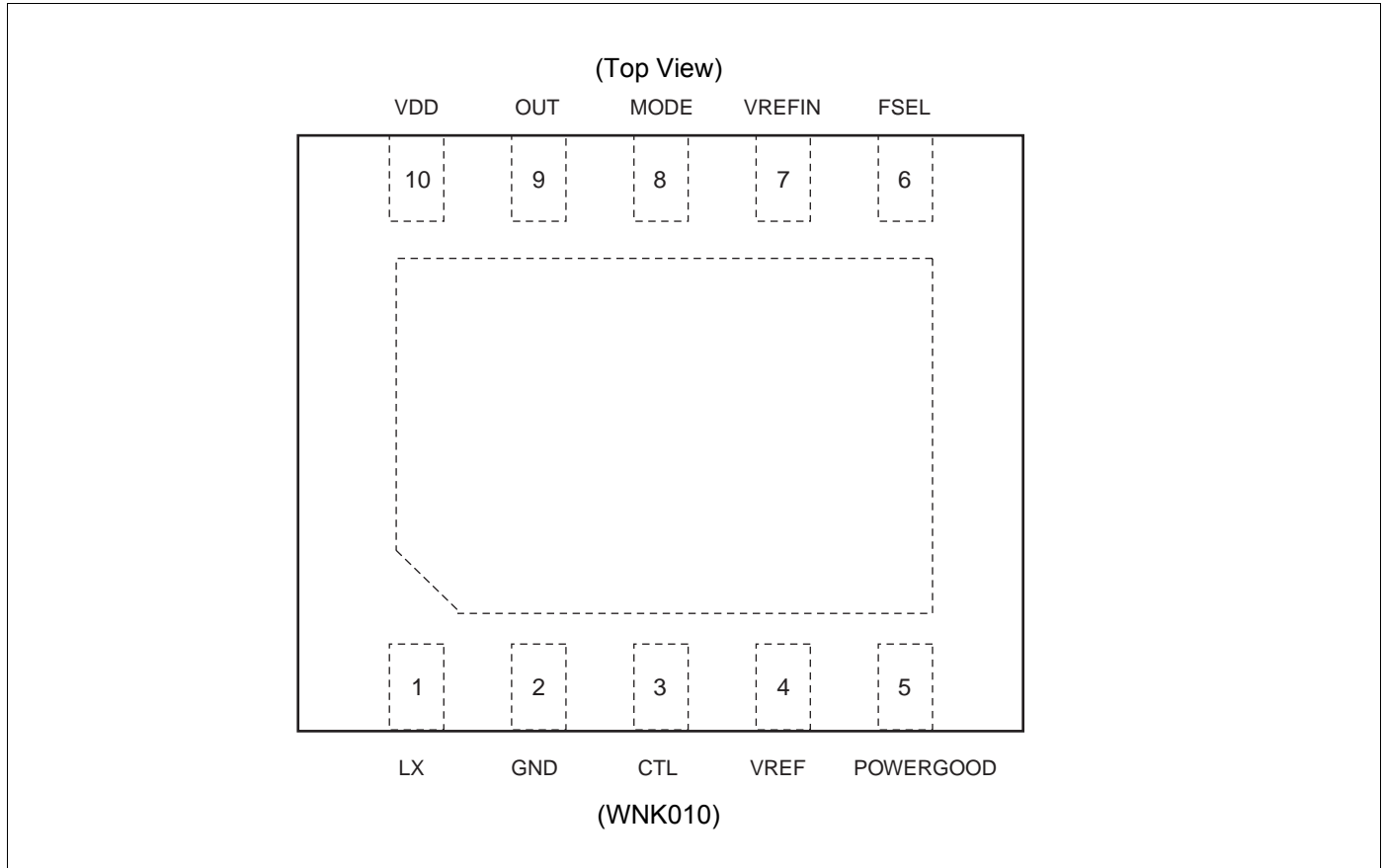

2. Pin Descriptions

Pin No	Pin Name	I/O	Description
1	LX	O	Inductor connection output pin. High impedance during shut down.
2	GND	—	Ground pin.
3	CTL	I	Control input pin. (L : Shut down / H : Normal operation)
4	VREF	O	Reference voltage output pin.
5	POWERGOOD	O	POWERGOOD circuit output pin. Internally connected to an N-ch MOS open drain circuit.
6	FSEL	I	Frequency switch pin. (L (open) : 2.0 MHz, H : 3.2 MHz)
7	VREFIN	I	Error amplifier (Error Amp) non-inverted input pin.
8	MODE	I	Operation mode switch pin. (L : PFM/PWM mode, OPEN : PWM mode)
9	OUT	I	Output voltage feedback pin.
10	VDD	—	Power supply pin.

3. I/O Pin Equivalent Circuit Diagram

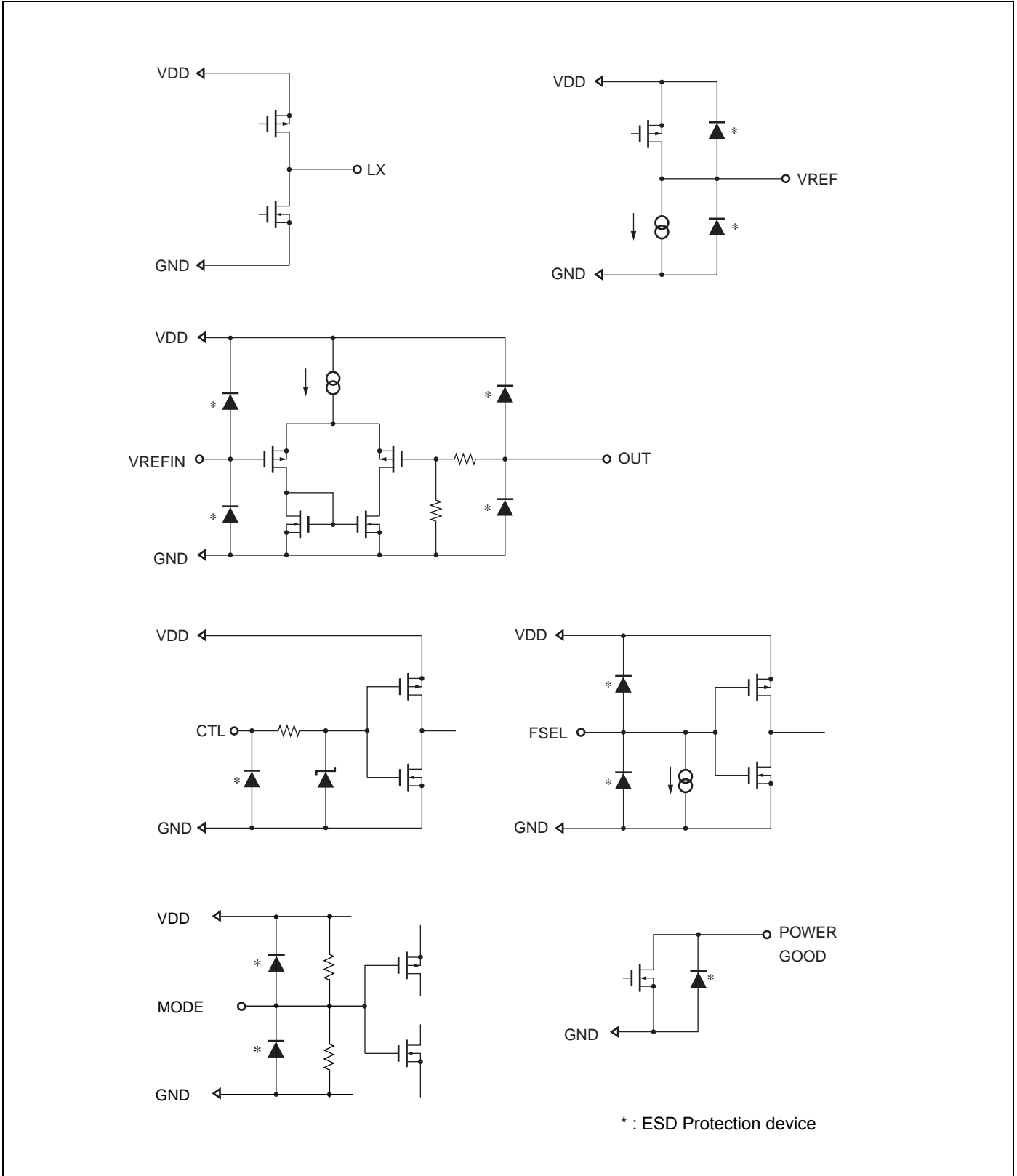

4. Block Diagram

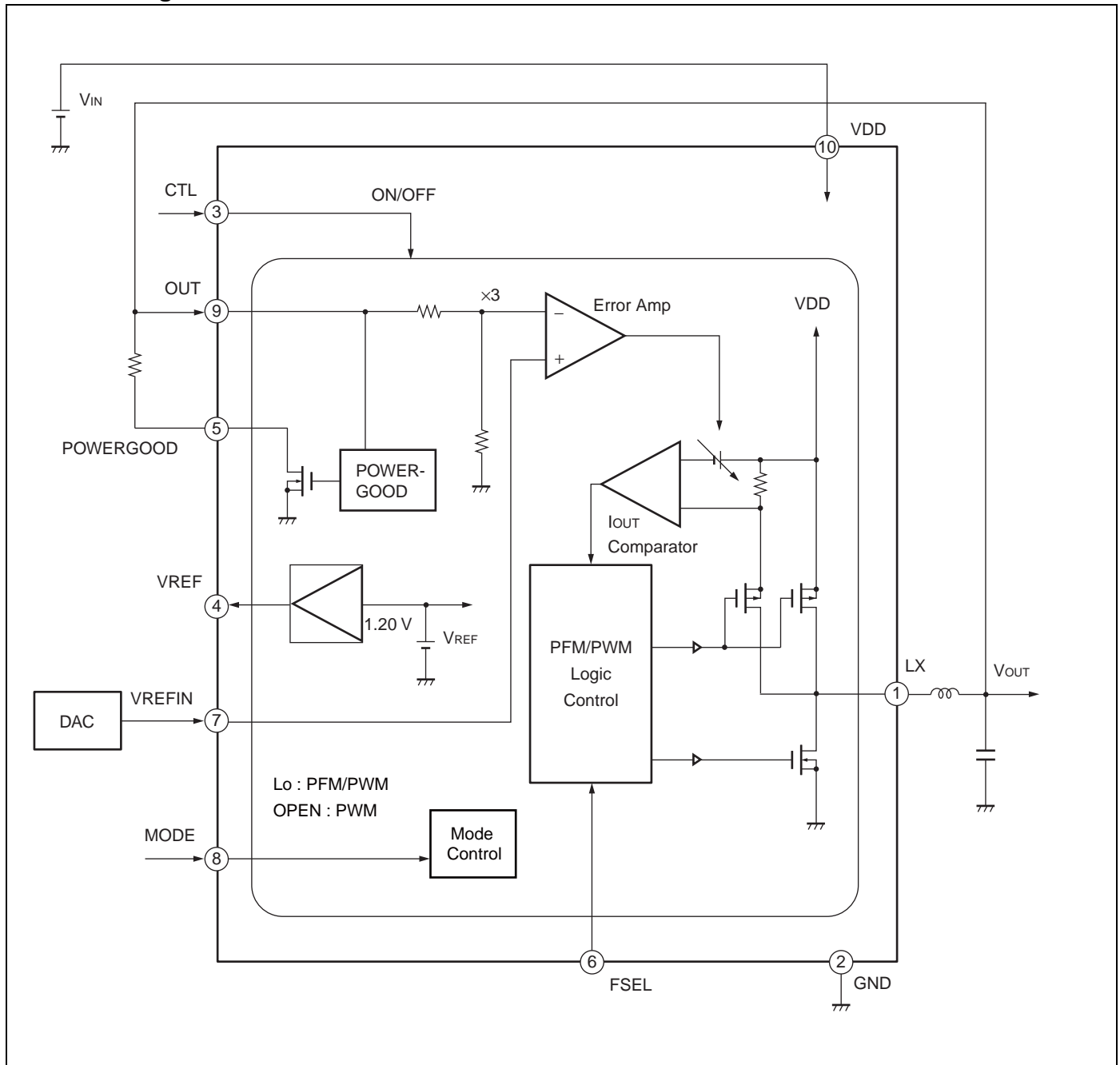

■ Current Mode

□ Original voltage mode type:

- Stabilize the output voltage by comparing two items below and on-duty control.
 - Voltage (V_C) obtained through negative feedback of the output voltage by Error Amp
 - Reference triangular wave (V_{TRI})

□ Current mode type:

- Instead of the triangular wave (V_{TRI}), the voltage (V_{IDET}) obtained through I-V conversion of the sum of currents that flow in the oscillator (rectangular wave generation circuit) and SW FET is used.
- Stabilize the output voltage by comparing two items below and on-duty control.

- Voltage (V_C) obtained through negative feedback of the output voltage by Error Amp
- Voltage (V_{IDET}) obtained through I-V conversion of the sum of current that flow in the oscillator (rectangular wave generation circuit) and SW FET

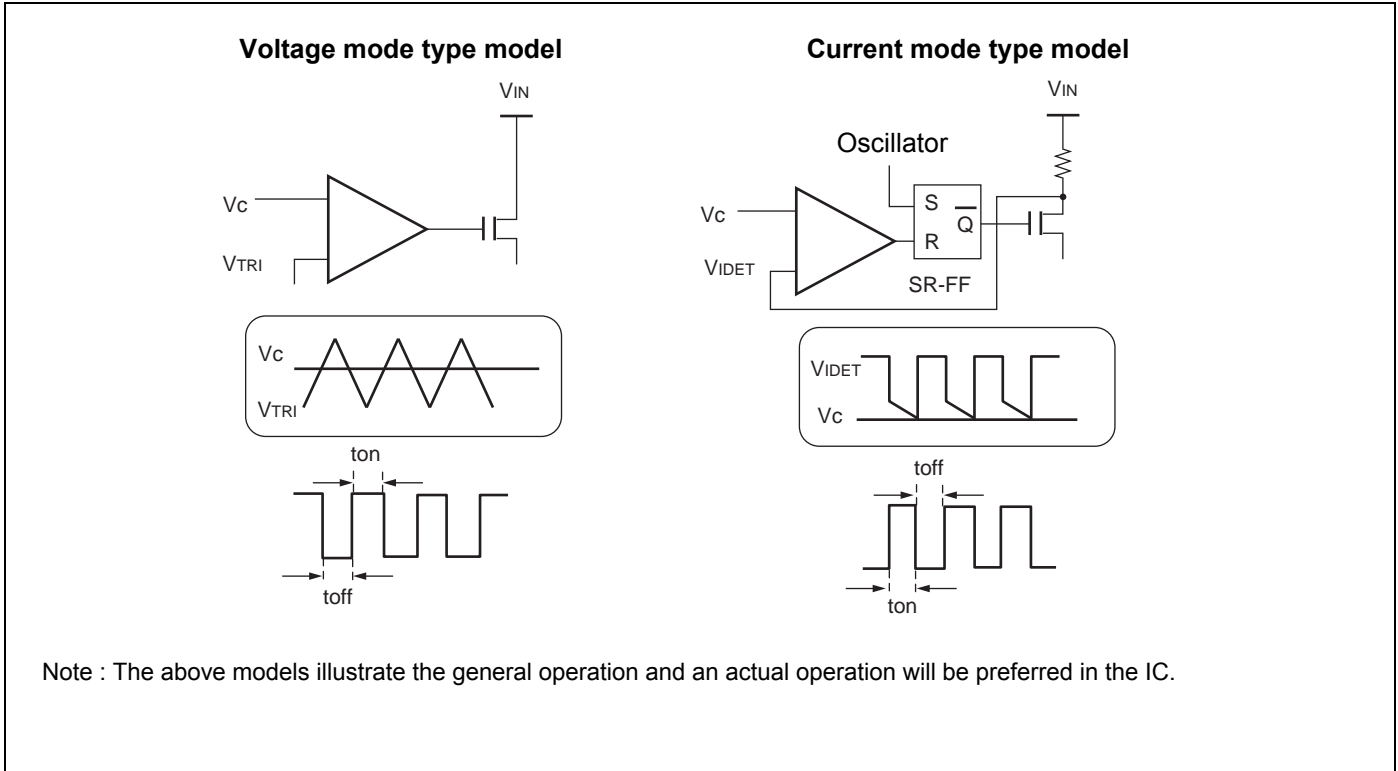

5. Function of Each Block

■ PFM/PWM Logic Control Circuit

In normal operation, frequency (2.0 MHz/3.2 MHz) which is set by the built-in oscillator (square wave oscillation circuit) controls the built-in P-ch MOS FET and N-ch MOS FET for the synchronous rectification operation. In the light load mode, the intermittent (PFM) operation is executed.

This circuit protects against pass-through current caused by synchronous rectification and against reverse current caused in a non-successive operation mode.

■ I_{OUT} Comparator Circuit

This circuit detects the current (I_{LX}) which flows to the external inductor from the built-in P-ch MOS FET.

By comparing V_{IDET} obtained through I-V conversion of peak current I_{PK} of I_{LX} with the Error Amp output, the built-in P-ch MOS FET is turned off via the PFM/PWM Logic Control circuit.

■ Error Amp Phase Compensation Circuit

This circuit compares the output voltage to reference voltages such as V_{REF} . The MB39C006A has a built-in phase compensation circuit that is designed to optimize the operation of the MB39C006A. This needs neither to be considered nor addition of a phase compensation circuit and an external phase compensation device.

■ V_{REF} Circuit

A high accuracy reference voltage is generated with BGR (bandgap reference) circuit. The output voltage is 1.20 V (Typ).

■ POWERGOOD Circuit

The POWERGOOD circuit monitors the voltage at the OUT pin. The POWERGOOD pin is open drain output. Use the pin with pull-up using the external resistor in the normal operation.

When the CTL is at the H level, the POWERGOOD pin becomes the H level. However, if the output voltage drops because of over current and etc, the POWERGOOD pin becomes the L level.

Timing Chart Example : (POWERGOOD Pin Pulled Up to VIN)

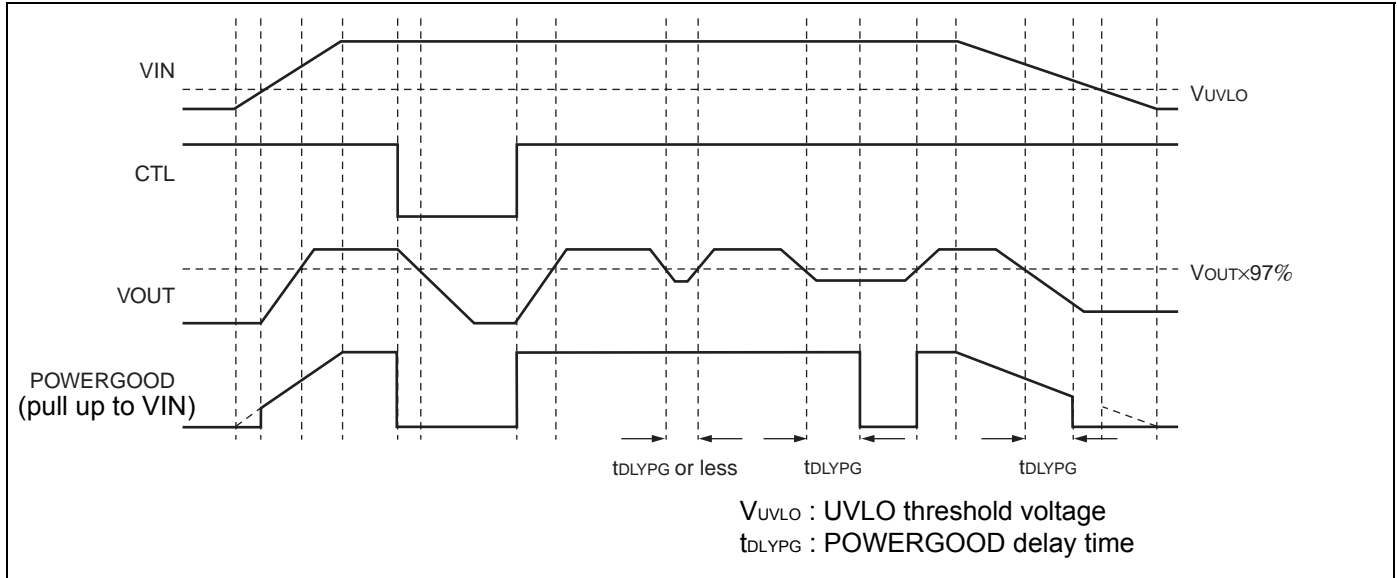

■ Protection Circuit

The MB39C006A has a built-in over-temperature protection circuit.

The over-temperature protection circuit turns off both N-ch and P-ch switching FETs when the junction temperature reaches +135 °C. When the junction temperature drops to +110 °C, the switching FET returns to the normal operation.

Since the PFM/PWM control circuit of the MB39C006A is in the control method in current mode, the current peak value is also monitored and controlled as required.

■ Function Table

MODE	Switching Frequency	Input			Output		
		CTL	MODE	FSEL	OUTPUT Pin Voltage	VREF	POWERGOOD
Shutdown mode	—	L	*	*	Output stop	Output stop	Function stop
PFM/PWM mode	2.0 MHz	H	L	L	VOUT voltage output	1.2 V	Operation
PWM fixed mode	2.0 MHz	H	OPEN	L	VOUT voltage output	1.2 V	Operation
PFM/PWM mode	3.2 MHz	H	L	H	VOUT voltage output	1.2 V	Operation
PWM fixed mode	3.2 MHz	H	OPEN	H	VOUT voltage output	1.2 V	Operation

* : Don't care

6. Absolute Maximum Ratings

Parameter	Symbol	Condition	Rating		Unit
			Min	Max	
Power supply voltage	V _{DD}	VDD pin	- 0.3	+ 6.0	V
Signal input voltage	V _{SIG}	OUT pin	- 0.3	V _{DD} + 0.3	V
		CTL, MODE, FSEL pins	- 0.3	V _{DD} + 0.3	
		VREFIN pin	- 0.3	V _{DD} + 0.3	
POWERGOOD pull-up voltage	V _{IPG}	POWERGOOD pin	- 0.3	+ 6.0	V
LX voltage	V _{LX}	LX pin	- 0.3	V _{DD} + 0.3	V
LX peak current	I _{PK}	The upper limit value of I _{LX}	—	1.8	A
Power dissipation	P _D	Ta ≤ + 25 °C	—	2632*1, *2, *3	mW
			—	980*1, *2, *4	
		Ta = + 85 °C	—	1053*1, *2, *3	mW
			—	392*1, *2, *4	
Operating ambient temperature	Ta	—	- 40	+ 85	°C
Storage temperature	T _{STG}	—	- 55	+ 125	°C

*1 : See “[Example of Standard Operation Characteristics](#) • Power dissipation vs. Operating ambient temperature” for the package power dissipation of Ta from + 25 °C to + 85 °C.

*2 : When mounted on a four-layer epoxy board of 11.7 cm × 8.4 cm

*3 : IC is mounted on a four-layer epoxy board, which has thermal via, and the IC's thermal pad is connected to the epoxy board (Thermal via is 4 holes).

*4 : IC is mounted on a four-layer epoxy board, which has no thermal via, and the IC's thermal pad is connected to the epoxy board.

Notes:

- The use of negative voltages below - 0.3 V to the GND pin may create parasitic transistors on LSI lines, which can cause abnormal operation.
- This device can be damaged if the LX pin is short-circuited to VDD pin or GND pin.
- Take measures not to keep the FSEL pin falling below the GND pin potential of the MB39C006A as much as possible. In addition to erroneous operation, the IC may latch up and destroy itself if 110 mA or more current flows from this pin.

WARNING: Semiconductor devices can be permanently damaged by application of stress (voltage, current, temperature, etc.) in excess of absolute maximum ratings. Do not exceed these ratings.

7. Recommended Operating Conditions

Parameter	Symbol	Condition	Value			Unit
			Min	Typ	Max	
Power supply voltage	V_{DD}	—	2.5	3.7	5.5	V
VREFIN voltage	V_{REFIN}	—	0.15	—	1.20	V
CTL voltage	V_{CTL}	—	0	—	5.0	V
LX current	I_{LX}	—	—	—	800	mA
POWERGOOD current	I_{PG}	—	—	—	1	mA
VREF output current	I_{ROUT}	$2.5\text{ V} \leq V_{DD} \leq 3.0\text{ V}$	—	—	0.5	mA
		$3.0\text{ V} \leq V_{DD} \leq 5.5\text{ V}$	—	—	1	
Inductor value	L	$f_{OSC1} = 2.0\text{ MHz (FSEL = L)}$	—	2.2	—	μH
		$f_{OSC2} = 3.2\text{ MHz (FSEL = H)}$	—	1.5	—	

Note : The output current from this device has a situation to decrease if the power supply voltage (V_{IN}) and the DC/DC converter output voltage (V_{OUT}) differ only by a small amount. This is a result of slope compensation and will not damage this device.

WARNING: The recommended operating conditions are required in order to ensure the normal operation of the semiconductor device. All of the device's electrical characteristics are warranted when the device is operated within these ranges.
 Always use semiconductor devices within their recommended operating condition ranges.
 Operation outside these ranges may adversely affect reliability and could result in device failure.
 No warranty is made with respect to uses, operating conditions, or combinations not represented on the data sheet. Users considering application outside the listed conditions are advised to contact their representatives beforehand.

8. Electrical Characteristics

(Ta = + 25 °C, VDD = 3.7 V, VOUT setting value = 2.5 V, MODE = 0 V)

Parameter	Symbol	Pin No.	Condition	Value			Unit		
				Min	Typ	Max			
DC/DC converter block	Input current	I _{REFINM}	7	V _{REFIN} = 0.833 V	-100	0	+ 100	nA	
		I _{REFINL}		V _{REFIN} = 0.15 V	-100	0	+ 100	nA	
		I _{REFINH}		V _{REFIN} = 1.20 V	-100	0	+ 100	nA	
	Output voltage	V _{OUT}	9	V _{REFIN} = 0.833 V, OUT = -100 mA	2.45	2.50	2.55	V	
	Input stability	LINE		2.5 V ≤ V _{DD} ≤ 5.5 V *1	—	10	—	mV	
	Load stability	LOAD		- 100 mA ≥ OUT ≥ - 800 mA	—	10	—	mV	
	Out pin input impedance	R _{OUT}		OUT = 2.0 V	0.6	1.0	1.5	MΩ	
	LX peak current	I _{PK}	1	Output shorted to GND	0.9	1.2	1.7	A	
	PFM/PWM switch current	I _{MSW}		FSEL = 0 V, L = 2.2 μH	—	30	—	mA	
	Oscillation frequency	f _{OSC1}		FSEL = 0 V	1.6	2.0	2.4	MHz	
		f _{OSC2}		FSEL = 3.7 V	2.56	3.20	3.84	MHz	
	Rise delay time	t _{PG}	3, 9	C1 = 4.7 μF, OUT = 0 A, VOUT = 90%	—	45	80	μs	
	SW NMOS FET OFF voltage	V _{NOFF}	1	—	—	-20*	—	mV	
	SW PMOS FET ON resistance	R _{ONP}		LX = -100 mA	—	0.30	0.47	Ω	
SW NMOS FET ON resistance	R _{ONN}	LX = -100 mA		—	0.20	0.36	Ω		
LX leak current	I _{LEAKM}	0 ≤ LX ≤ V _{DD} *2		-1.0	—	+ 8.0	μA		
	I _{LEAKH}	V _{DD} = 5.5 V, 0 ≤ LX ≤ V _{DD} *2		-2.0	—	+ 16.0	μA		
Protection circuit block	Over temperature protection (Junction Temp.)	T _{OTPH}	—	—	+ 120*	+ 135*	+ 155*	°C	
		T _{OTPL}			+ 95*	+ 110*	+ 130*	°C	
	UVLO threshold voltage	V _{THH}	10	—	—	2.07	2.20	2.33	V
		V _{THL}				1.92	2.05	2.18	V
	UVLO hysteresis width	V _{HYS}	—	—	—	0.08	0.15	0.25	V

* : This value isn't be specified. This should be used as a reference to support designing the circuits.

(Ta = + 25 °C, VDD = 3.7 V, VOUT setting value = 2.5 V, MODE = 0 V)

Parameter		Symbol	Pin No.	Condition	Value			Unit
					Min	Typ	Max	
POWER-GOOD block	POWERGOOD threshold voltage	V _{THPG}	5	*3	V _{REFIN} × 3 × 0.93	V _{REFIN} × 3 × 0.97	V _{REFIN} × 3 × 0.99	V
	POWERGOOD delay time	t _{DLYPG1}		FSEL = 0 V	—	250	—	μs
		t _{DLYPG2}		FSEL = 3.7 V	—	170	—	μs
	POWERGOOD output voltage	V _{OL}		POWERGOOD = 250 μA	—	—	0.1	V
POWERGOOD output current	I _{OH}	POWERGOOD = 5.5 V	—	—	1.0	μA		
Control block	CTL threshold voltage	V _{THHCT}	3	—	0.55	0.95	1.45	V
		V _{THLCT}		—	0.40	0.80	1.30	V
	CTL pin input current	I _{ICTL}	3	CTL = 3.7 V	—	—	1.0	μA
	MODE threshold voltage	V _{THMMD}	8	OPEN setting	—	1.5	—	V
		V _{THLMD}		—	—	—	0.4	V
	MODE pin input current	I _{LMMD}	8	MODE = 0 V	-0.8	-0.4	—	μA
FSEL threshold voltage	V _{THHFS}	6	—	2.96	—	—	V	
	V _{THLFS}		—	—	—	0.74	V	
Reference voltage block	VREF voltage	V _{REF}	4	VREF = -2.7 μA, OUT = -100 mA	1.176	1.200	1.224	V
	VREF load stability	LOADREF		VREF = -1.0 mA	—	—	20	mV
General	Shut down power supply current	I _{VDD1}	10	CTL = 0 V, All circuits in OFF state	—	—	1.0	μA
		I _{VDD1H}		CTL = 0 V, VDD = 5.5 V	—	—	1.0	μA
	Power supply current at DC/DC operation (PFM mode)	I _{VDD2}		CTL = 3.7 V, MODE = 0 V, OUT = 0 A	—	30	48	μA
	Power supply current at DC/DC operation (PWM fixed mode)	I _{VDD2}		CTL = 3.7 V, MODE = OPEN, OUT = 0 A, FSEL = 0 V	—	4.8	8.0	mA
	Power-on invalid current	I _{VDD}		CTL = 3.7 V, VOUT = 90%*4	—	800	1500	μA

*1 : The minimum value of V_{DD} is the 2.5 V or V_{OUT} setting value + 0.6 V, whichever is higher.

*2 : The + leak at the LX pin includes the current of the internal circuit.

*3 : Detected with respect to the output voltage setting value of V_{REFIN}

*4 : Current consumption based on 100% ON-duty (High side FET in full ON state). The SW FET gate drive current is not included because the device is in full ON state (no switching operation). Also the load current is not included.

9. Test Circuit for Measuring Typical Operating Characteristics

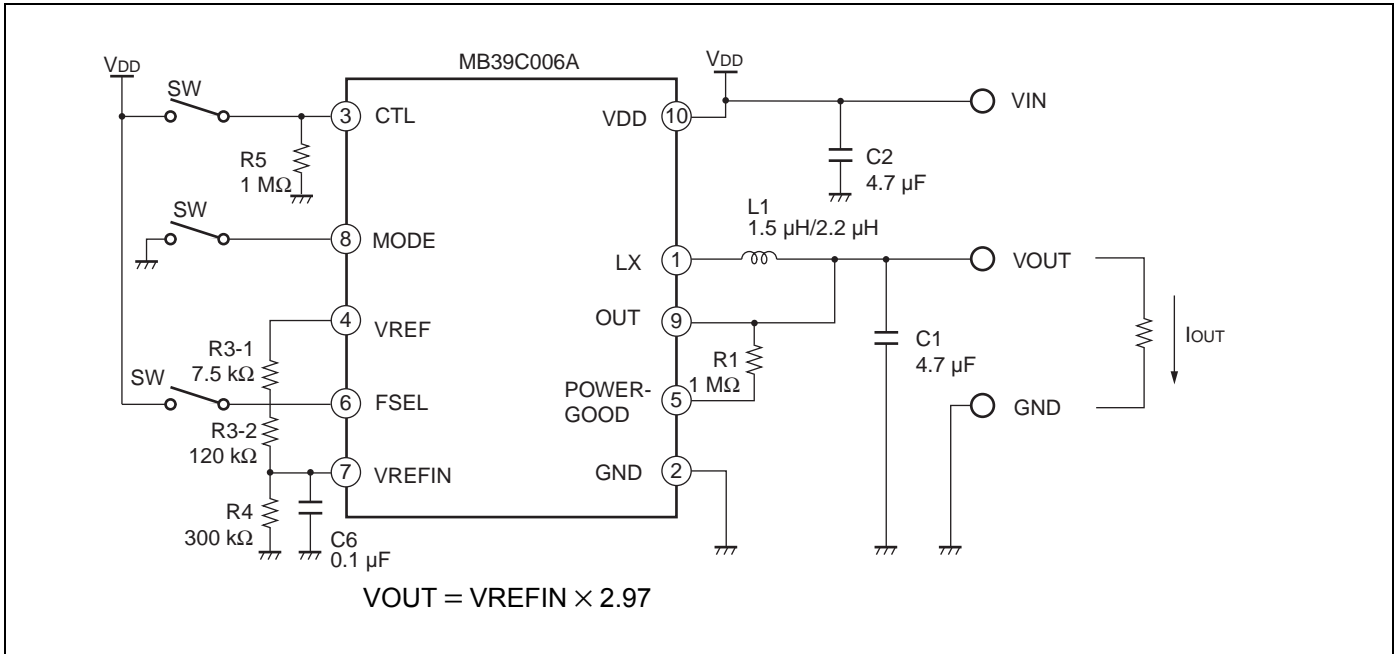

Component	Specification	Vendor	Part Number	Remark
R1	1 MΩ	KOA	RK73G1JT D 1 MΩ	
R3-1	7.5 kΩ	SSM	RR0816-752-D	At VOUT = 2.5 V setting
R3-2	120 kΩ	SSM	RR0816-124-D	
R4	300 kΩ	SSM	RR0816-304-D	
R5	1 MΩ	KOA	RK73G1JT D 1 MΩ	
C1	4.7 μF	TDK	C2012JB1A475K	
C2	4.7 μF	TDK	C2012JB1A475K	
C6	0.1 μF	TDK	C1608JB1H104K	For adjusting slow start time
L1	2.2 μH	TDK	VLF4012AT-2R2M	2.0 MHz operation
	1.5 μH	TDK	VLF4012AT-1R5M	3.2 MHz operation

Note : These components are recommended based on the operating tests authorized.

TDK : TDK Corporation
SSM : SUSUMU Co., Ltd
KOA : KOA Corporation

10. Application Notes

10.1 Selection of Components

■ Selection of an External Inductor

Basically it does not need to design inductor. The MB39C006A is designed to operate efficiently with a 2.2 μH (2.0 MHz operation) or 1.5 μH (3.2 MHz operation) external inductor.

The inductor should be rated for a saturation current higher than the LX peak current value during normal operating conditions, and should have a minimal DC resistance. (100 mΩ or less is recommended.)

The LX peak current value I_{PK} is obtained by the following formula.

$$I_{PK} = I_{OUT} + \frac{V_{IN} - V_{OUT}}{L} \times \frac{D}{f_{osc}} \times \frac{1}{2} = I_{OUT} + \frac{(V_{IN} - V_{OUT}) \times V_{OUT}}{2 \times L \times f_{osc} \times V_{IN}}$$

L : External inductor value

I_{OUT} : Load current

V_{IN} : Power supply voltage

V_{OUT} : Output setting voltage

D : ON- duty to be switched (= V_{OUT}/V_{IN})

fosc : Switching frequency (2.0 MHz or 3.2 MHz)

ex) At $V_{IN} = 3.7$ V, $V_{OUT} = 2.5$ V, $I_{OUT} = 0.8$ A, $L = 2.2$ μH, $f_{osc} = 2.0$ MHz

The maximum peak current value I_{PK} ;

$$I_{PK} = I_{OUT} + \frac{(V_{IN} - V_{OUT}) \times V_{OUT}}{2 \times L \times f_{osc} \times V_{IN}} = 0.8 \text{ A} + \frac{(3.7 \text{ V} - 2.5 \text{ V}) \times 2.5 \text{ V}}{2 \times 2.2 \text{ μH} \times 2 \text{ MHz} \times 3.7 \text{ V}} \approx 0.89 \text{ A}$$

■ I/O Capacitor Selection

- Select a low equivalent series resistance (ESR) for the VDD input capacitor to suppress dissipation from ripple currents.
- Also select a low equivalent series resistance (ESR) for the output capacitor. The variation in the inductor current causes ripple currents on the output capacitor which, in turn, causes ripple voltages on output equal to the amount of variation multiplied by the ESR value. The output capacitor value has a significant impact on the operating stability of the device when used as a DC/DC converter. Therefore, Cypress generally recommends a 4.7 μF capacitor, or a larger capacitor value can be used if ripple voltages are not suitable. If the V_{IN}/V_{OUT} voltage difference is within 0.6 V, the use of a 10 μF output capacitor value is recommended.
- Types of capacitors
Ceramic capacitors are effective for reducing the ESR and afford smaller DC/DC converter circuit. However, power supply functions as a heat generator, therefore avoid to use capacitor with the F-temperature rating (−80% to +20%). Cypress recommends capacitors with the B-temperature rating ($\pm 10\%$ to $\pm 20\%$). Normal electrolytic capacitors are not recommended due to their high ESR.
Tantalum capacitor will reduce ESR, however, it is dangerous to use because it turns into short mode when damaged. If you insist on using a tantalum capacitor, Cypress recommends the type with an internal fuse.

10.2 Output Voltage Setting

The output voltage V_{OUT} of the MB39C006A is defined by the voltage input to VREFIN. Supply the voltage for inputting to VREFIN from an external power supply, or set the VREF output by dividing it with resistors.

The output voltage when the VREFIN voltage is set by dividing the VREF voltage with resistors is shown in the following formula.

$$V_{OUT} = 2.97 \times V_{REFIN}, \quad V_{REFIN} = \frac{R4}{R3 + R4} \times V_{REF}$$

($V_{REF} = 1.20$ V)

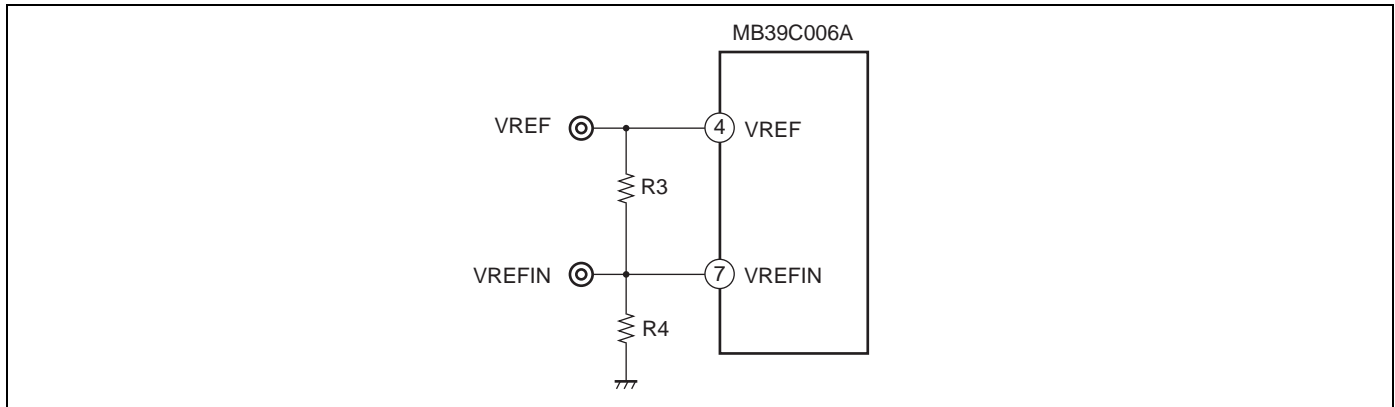

Note : See “[Application Circuit Examples](#)” for an example of this circuit.

Although the output voltage is defined according to the dividing ratio of resistance, select the resistance value so that the current flowing through the resistance does not exceed the VREF current rating (1 mA) .

10.3 About Conversion Efficiency

The conversion efficiency can be improved by reducing the loss of the DC/DC converter circuit.

The total loss (P_{LOSS}) of the DC/DC converter is roughly divided as follows :

$$P_{LOSS} = P_{CONT} + P_{SW} + P_C$$

P_{CONT} : Control system circuit loss (The power to operate the MB39C006A, including the gate driving power for internal SW FETs)

P_{SW} : Switching loss (The loss caused during the switch of the IC's internal SW FETs)

P_C : Continuity loss (The loss caused when currents flow through the IC's internal SW FETs and external circuits)

The IC's control circuit loss (P_{CONT}) is extremely small, several tens of mW* with no load.

As the IC contains FETs which can switch faster with less power, the continuity loss (P_C) is more predominant as the loss during heavy-load operation than the control circuit loss (P_{CONT}) and switching loss (P_{SW}) .

* : The loss in the successive operation mode. This IC suppresses the loss in order to execute the PFM operation in the low load mode (less than 100 μ A in no load mode). Mode is changed by the current peak value I_{PK} which flows into switching FET. The threshold value is about 30 mA.

Furthermore, the continuity loss (P_C) is divided roughly into the loss by internal SW FET ON-resistance and by external inductor series resistance.

$$P_C = I_{OUT}^2 \times (RDC + D \times R_{ONP} + (1 - D) \times R_{ONN})$$

D : Switching ON-duty cycle (= V_{OUT} / V_{IN})

R_{ONP} : Internal P-ch SW FET ON resistance

R_{ONN} : Internal N-ch SW FET ON resistance

RDC : External inductor series resistance

I_{OUT} : Load current

The above formula indicates that it is important to reduce RDC as much as possible to improve efficiency by selecting components.

10.4 Power Dissipation and Heat Considerations

The IC is so efficient that no consideration is required in most of the cases. However, if the IC is used at a low power supply voltage, heavy load, high output voltage, or high temperature, it requires further consideration for higher efficiency.

The internal loss (P) is roughly obtained from the following formula :

$$P = I_{OUT}^2 \times (D \times R_{ONP} + (1 - D) \times R_{ONN})$$

D : Switching ON-duty cycle (= V_{OUT} / V_{IN})

R_{ONP} : Internal P-ch SW FET ON resistance

R_{ONN} : Internal N-ch SW FET ON resistance

I_{OUT} : Output current

The loss expressed by the above formula is mainly continuity loss. The internal loss includes the switching loss and the control circuit loss as well but they are so small compared to the continuity loss they can be ignored.

In the MB39C006A with R_{ONP} greater than R_{ONN}, the larger the on-duty cycle, the greater the loss.

When assuming V_{IN} = 3.7 V, Ta = + 70 °C for example, R_{ONP} = 0.42 Ω and R_{ONN} = 0.36 Ω according to the graph “MOS FET ON resistance vs. Operating ambient temperature”. The IC’s internal loss P is 144 mW at V_{OUT} = 2.5 V and I_{OUT} = 0.6 A. According to the graph “Power dissipation vs. Operating ambient temperature”, the power dissipation at an operating ambient temperature Ta of + 70 °C is 539 mW and the internal loss is smaller than the power dissipation.

10.5 Transient Response

Normally, I_{OUT} is suddenly changed while V_{IN} and V_{OUT} are maintained constant, responsiveness including the response time and overshoot/undershoot voltage is checked. As the MB39C006A has built-in Error Amp with an optimized design, it shows good transient response characteristics. However, if ringing upon sudden change of the load is high due to the operating conditions, add capacitor C6 (e.g. 0.1 μF). (Since this capacitor C6 changes the start time, check the start waveform as well.) This action is not required for DAC input.

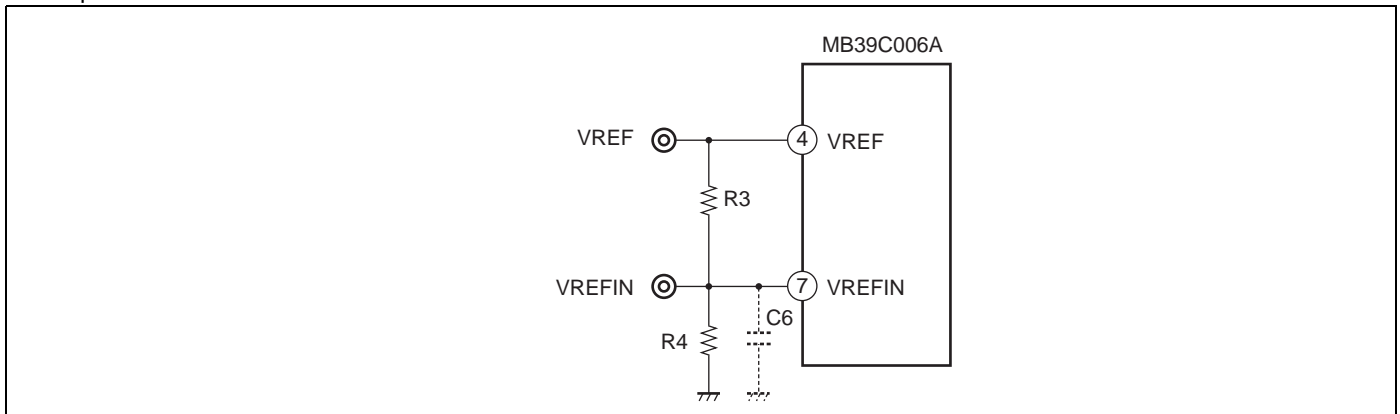

10.6 Board Layout, Design Example

The board layout needs to be designed to ensure the stable operation of the MB39C006A.

Follow the procedure below for designing the layout.

- Arrange the input capacitor (C_{in}) as close as possible to both the VDD and GND pins. Make a through hole (TH) near the pins of this capacitor if the board has planes for power and GND.
- Large AC currents flow between the MB39C006A and the input capacitor (C_{in}), output capacitor (C_o), and external inductor (L). Group these components as close as possible to the MB39C006A to reduce the overall loop area occupied by this group. Also try to mount these components on the same surface and arrange wiring without through hole wiring. Use thick, short, and straight routes to wire the net (The layout by planes is recommended.).
- The feedback wiring to the OUT should be wired from the voltage output pin closest to the output capacitor (C_o). The OUT pin is extremely sensitive and should thus be kept wired away from the LX pin of the MB39C006A as far as possible.

- If applying voltage to the VREFIN pin through dividing resistors, arrange the resistors so that the wiring can be kept as short as possible. Also arrange them so that the GND pin of the VREFIN resistor is close to the IC's GND pin. Further, provide a GND exclusively for the control line so that the resistor can be connected via a path that does not carry current. If installing a bypass capacitor for the VREFIN, put it close to the VREFIN pin.
- Try to make a GND plane on the surface to which the MB39C006A will be mounted. For efficient heat dissipation when using the SON 10 package, Cypress recommends providing a thermal via in the footprint of the thermal pad.

■ Layout Example of IC SW Components

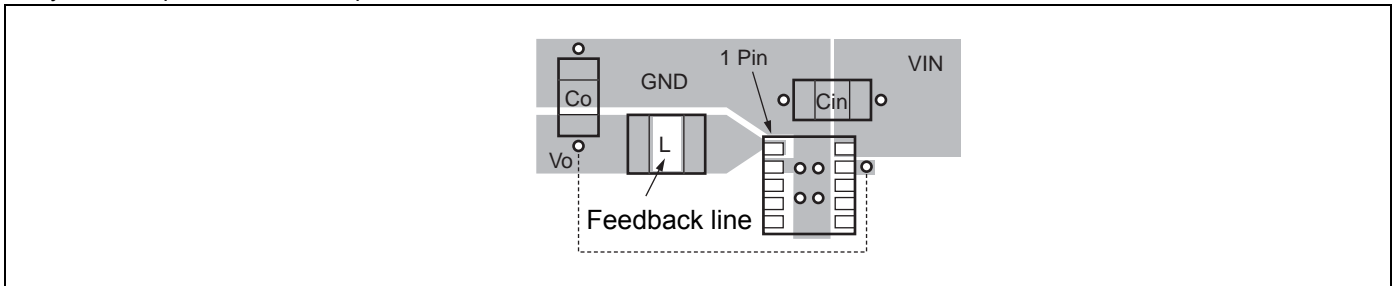

■ Notes for Circuit Design

The switching operation of the MB39C006A works by monitoring and controlling the peak current which, incidentally, serves as form of short-circuit protection. However, do not leave the output short-circuited for long periods of time. If the output is short-circuited where $V_{IN} < 2.9\text{ V}$, the current limit value (peak current to the inductor) tends to rise. Leaving in the short-circuit state, the temperature of the MB39C006A will continue rising and activate the thermal protection.

Once the thermal protection stops the output, the temperature of the IC will go down and operation will resume, after which the output will repeat the starting and stopping.

Although this effect will not destroy the IC, the thermal exposure to the IC over prolonged hours may affect the peripherals surrounding it.

11. Example of Standard Operation Characteristics

(Shown below is an example of characteristics for connection according to [Test Circuit for Measuring Typical Operating Characteristics.](#))

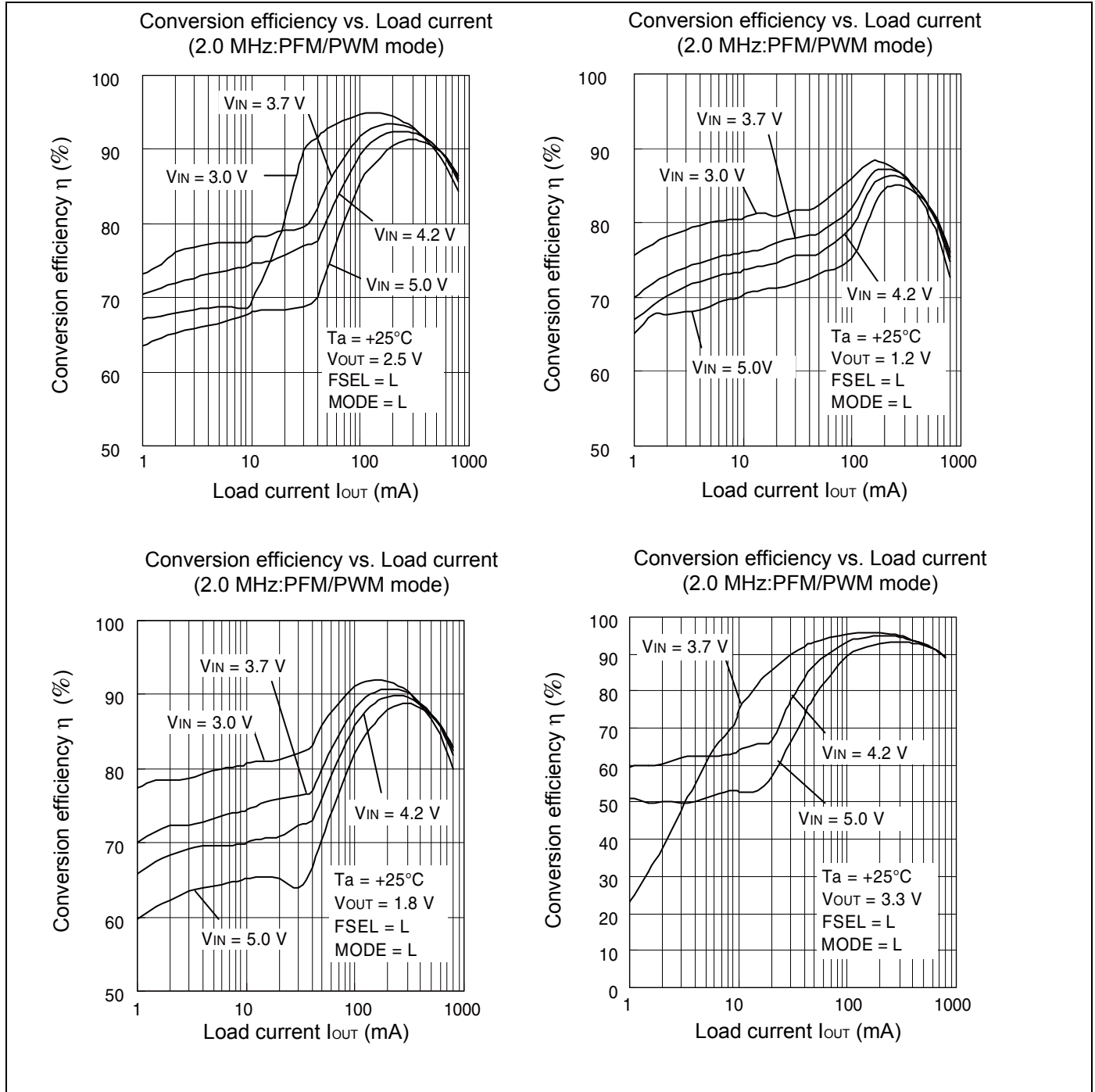

Conversion efficiency vs. Load current
(2.0 MHz:PWM fixed mode)

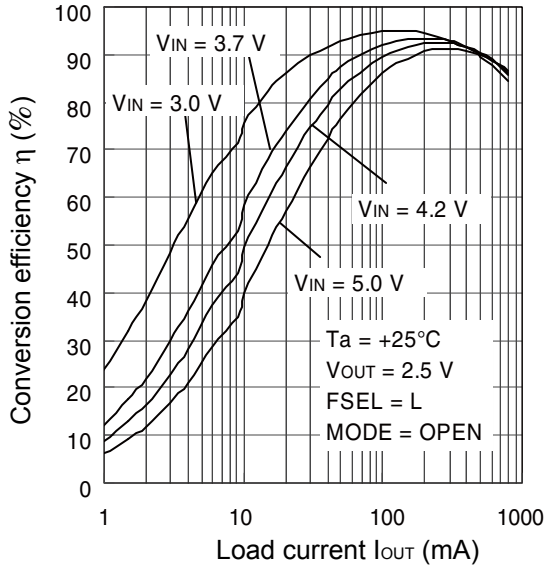

Conversion efficiency vs. Load current
(2.0 MHz:PWM fixed mode)

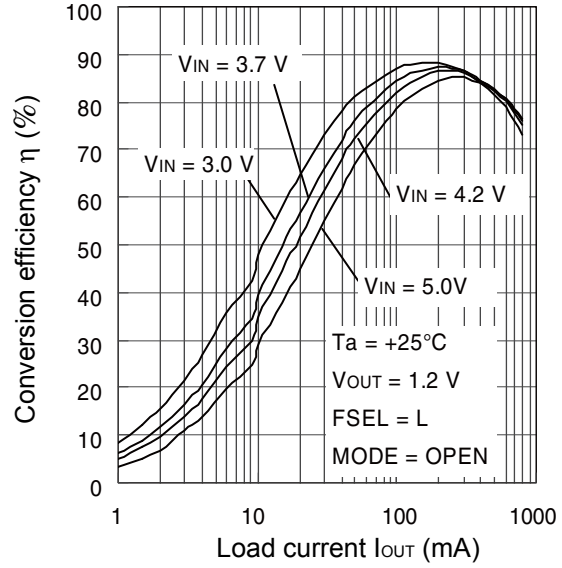

Conversion efficiency vs. Load current
(2.0 MHz:PWM fixed mode)

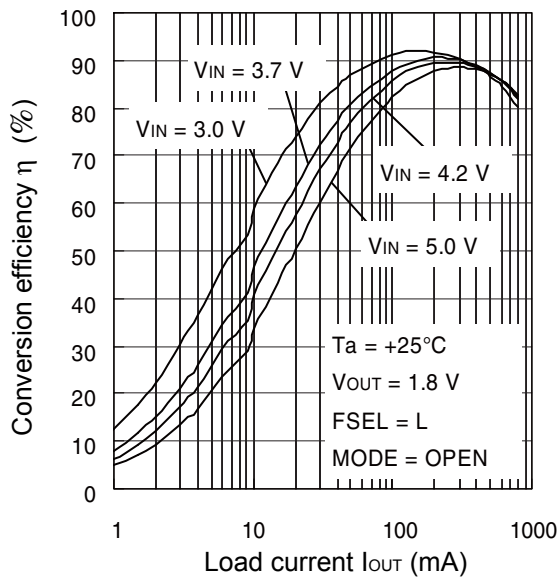

Conversion efficiency vs. Load current
(2.0 MHz:PWM fixed mode)

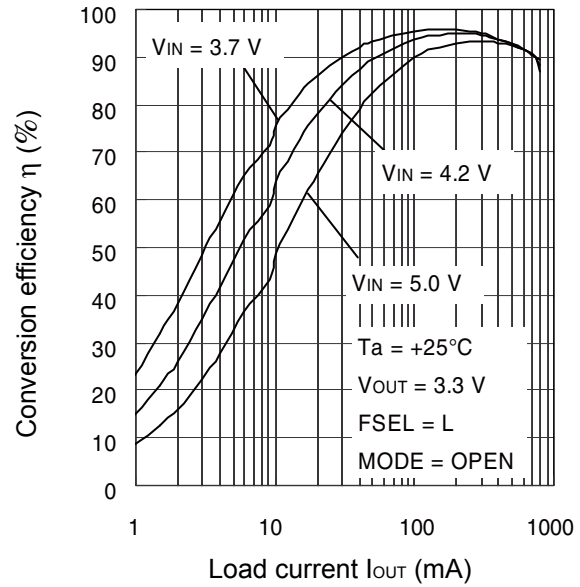

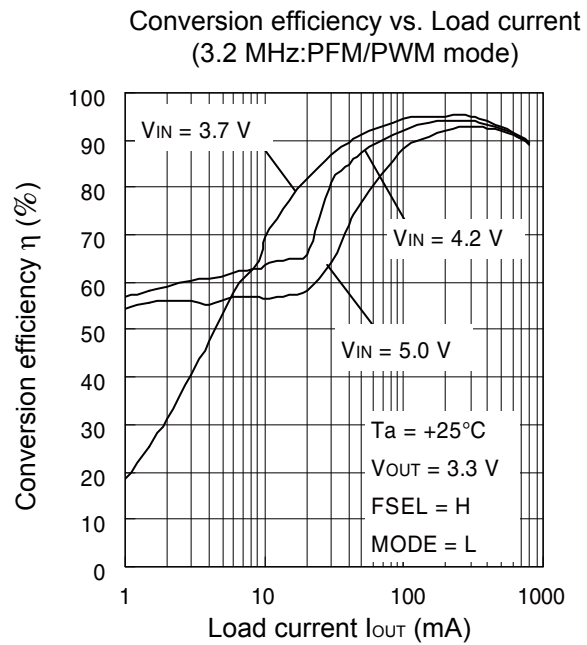
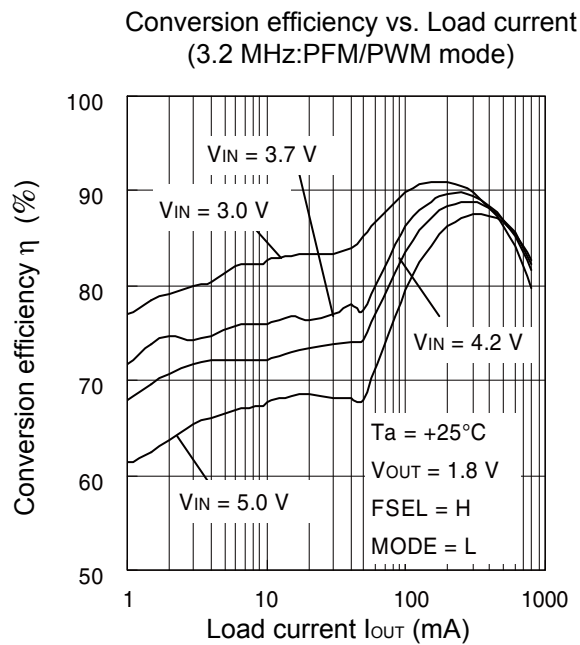
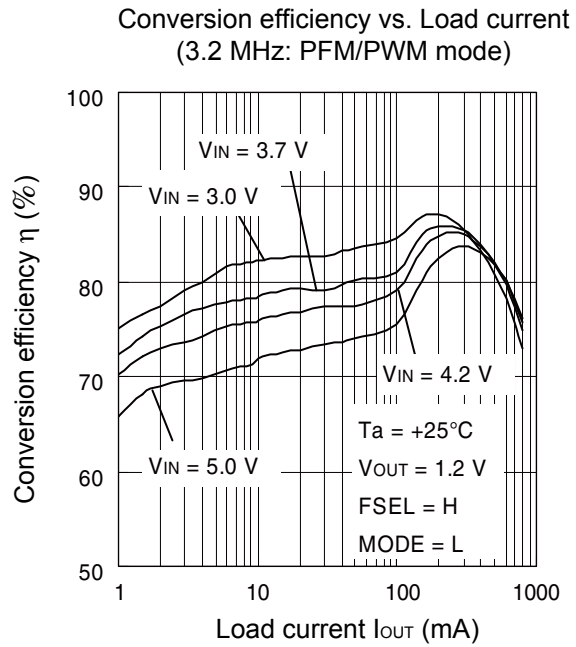
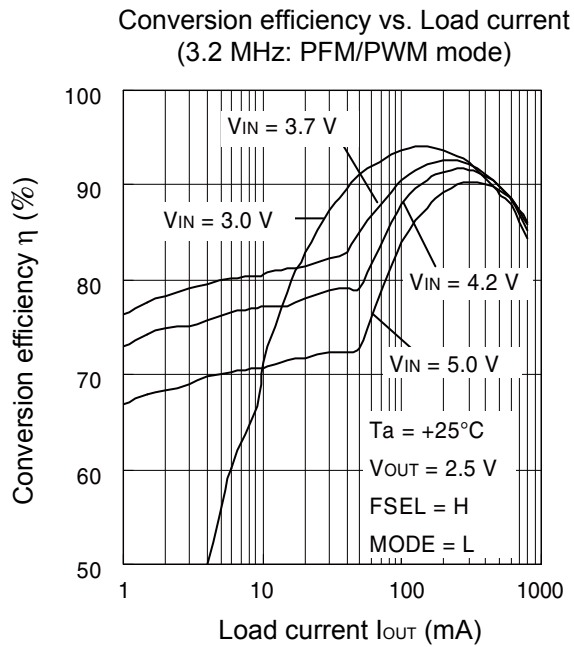

Conversion efficiency vs. Load current
(3.2 MHz:PWM fixed mode)

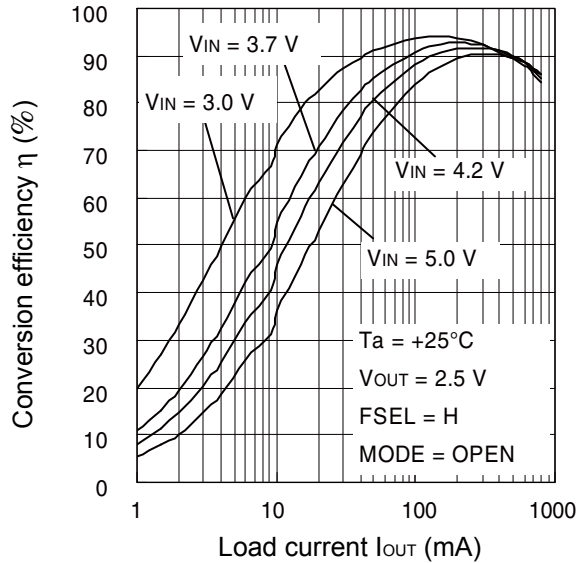

Conversion efficiency vs. Load current
(3.2 MHz:PWM fixed mode)

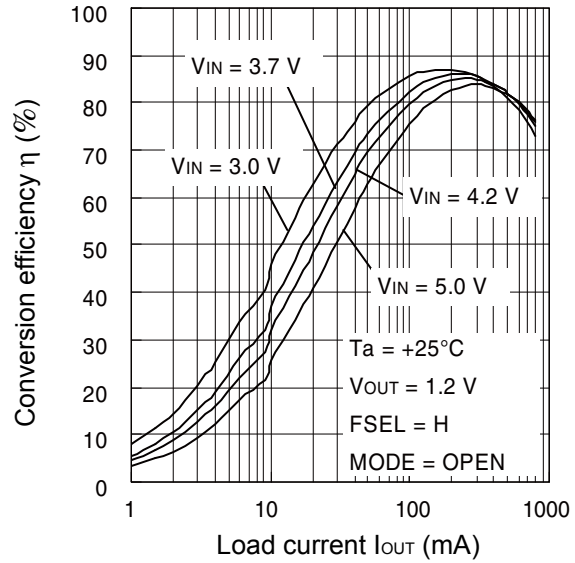

Conversion efficiency vs. Load current
(3.2 MHz:PWM fixed mode)

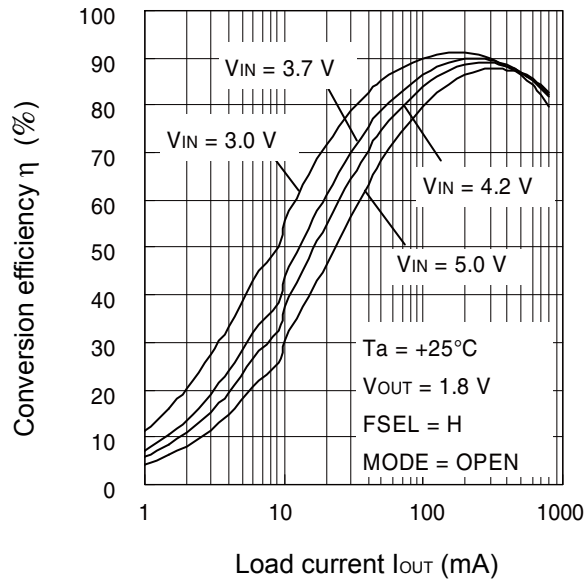

Conversion efficiency vs. Load current
(3.2 MHz:PWM fixed mode)

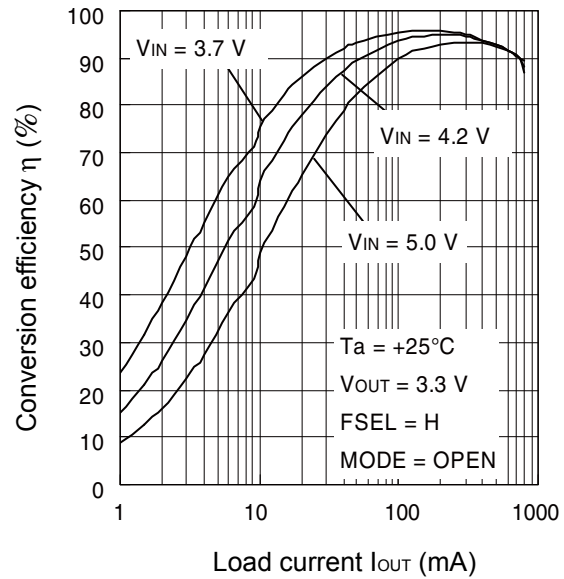

Output voltage vs. Input voltage
(2.0 MHz: PFM/PWM mode)

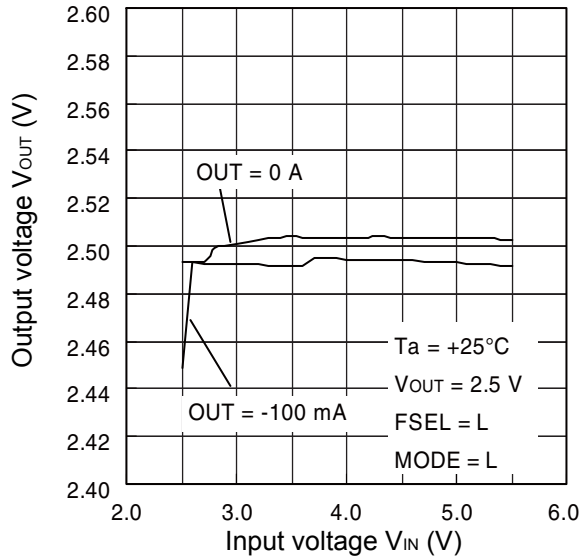

Output voltage vs. Input voltage
(3.2 MHz: PFM/PWM mode)

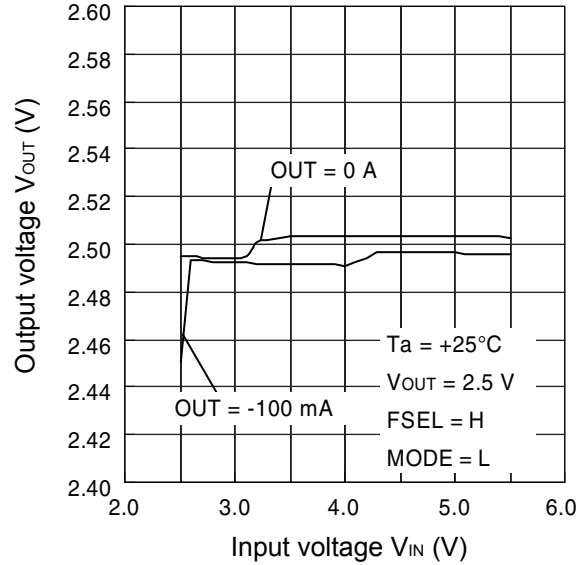

Output voltage vs. Input voltage
(2.0 MHz: PWM fixed mode)

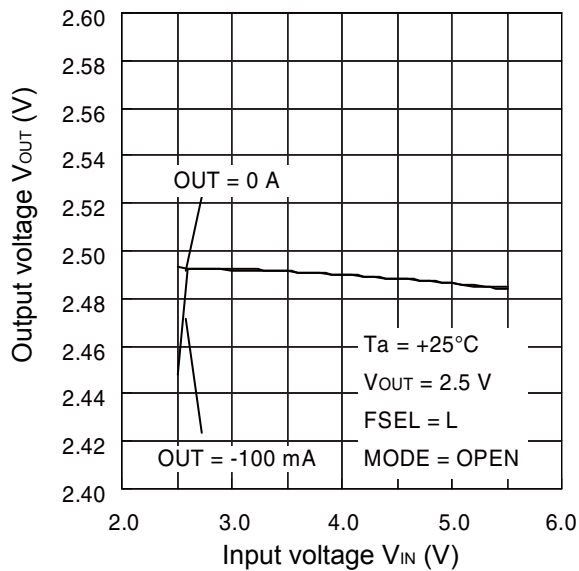

Output voltage vs. Input voltage
(3.2 MHz: PWM fixed mode)

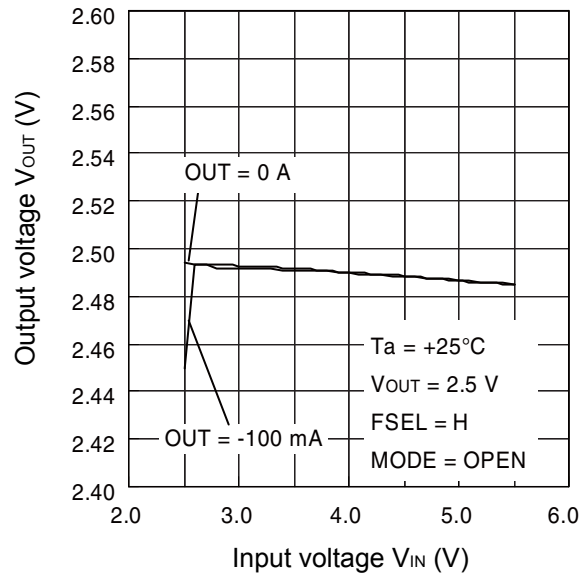

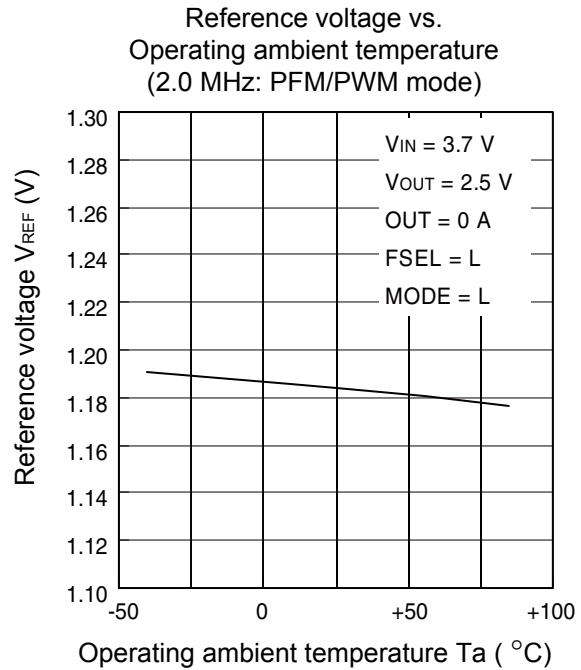
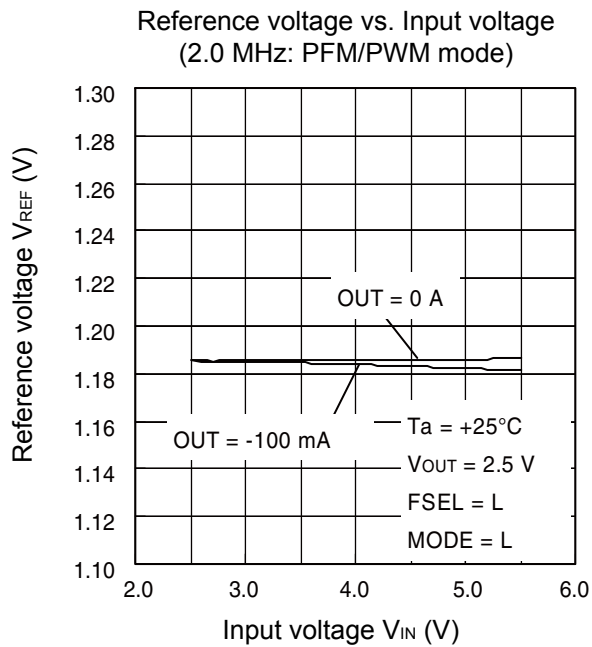
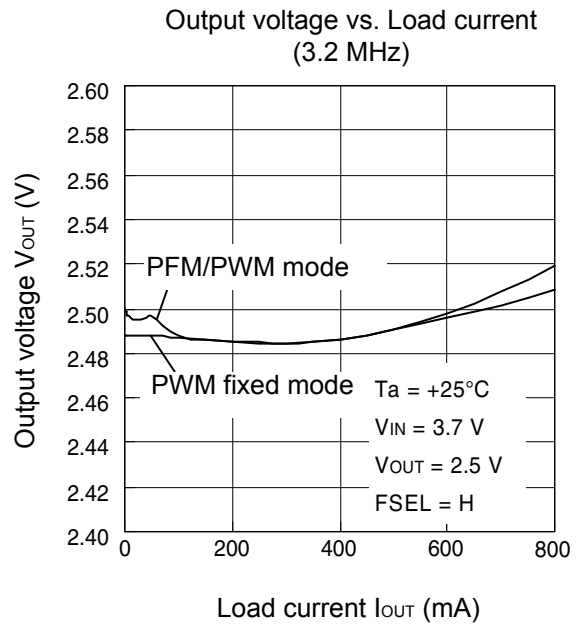
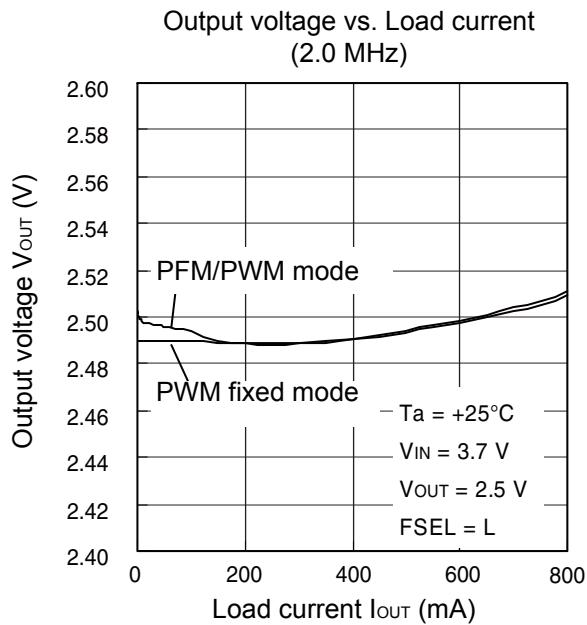

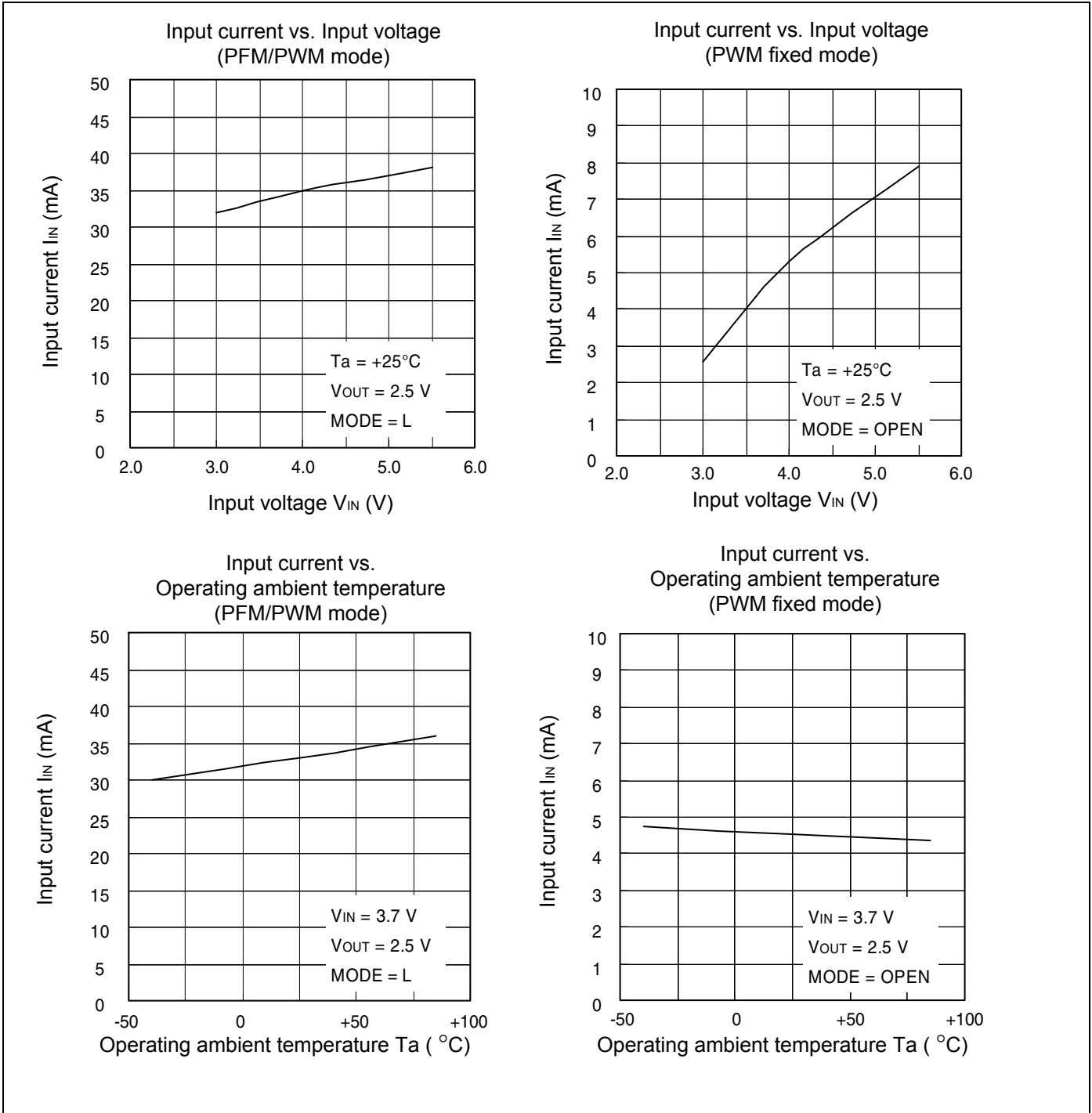

Oscillation frequency vs. Input voltage
(2.0 MHz)

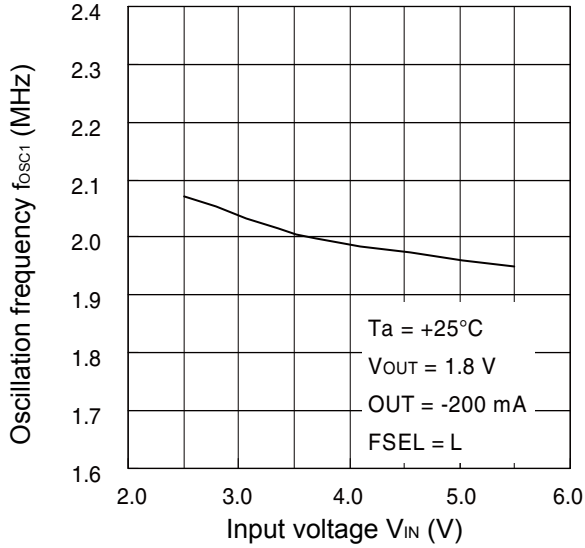

Oscillation frequency vs. Input voltage
(3.2 MHz)

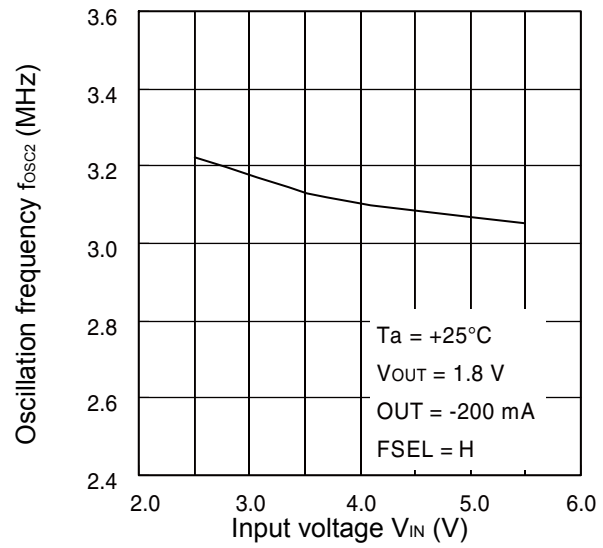

Oscillation frequency vs.
Operating ambient temperature
(2.0 MHz)

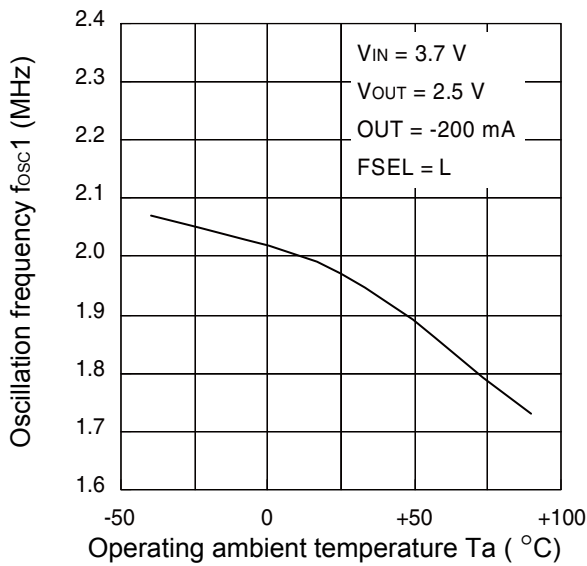

Oscillation frequency vs.
Operating ambient temperature
(3.2 MHz)

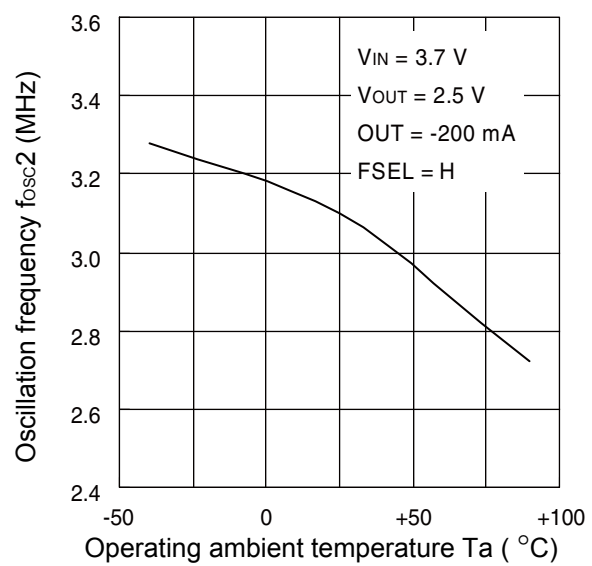

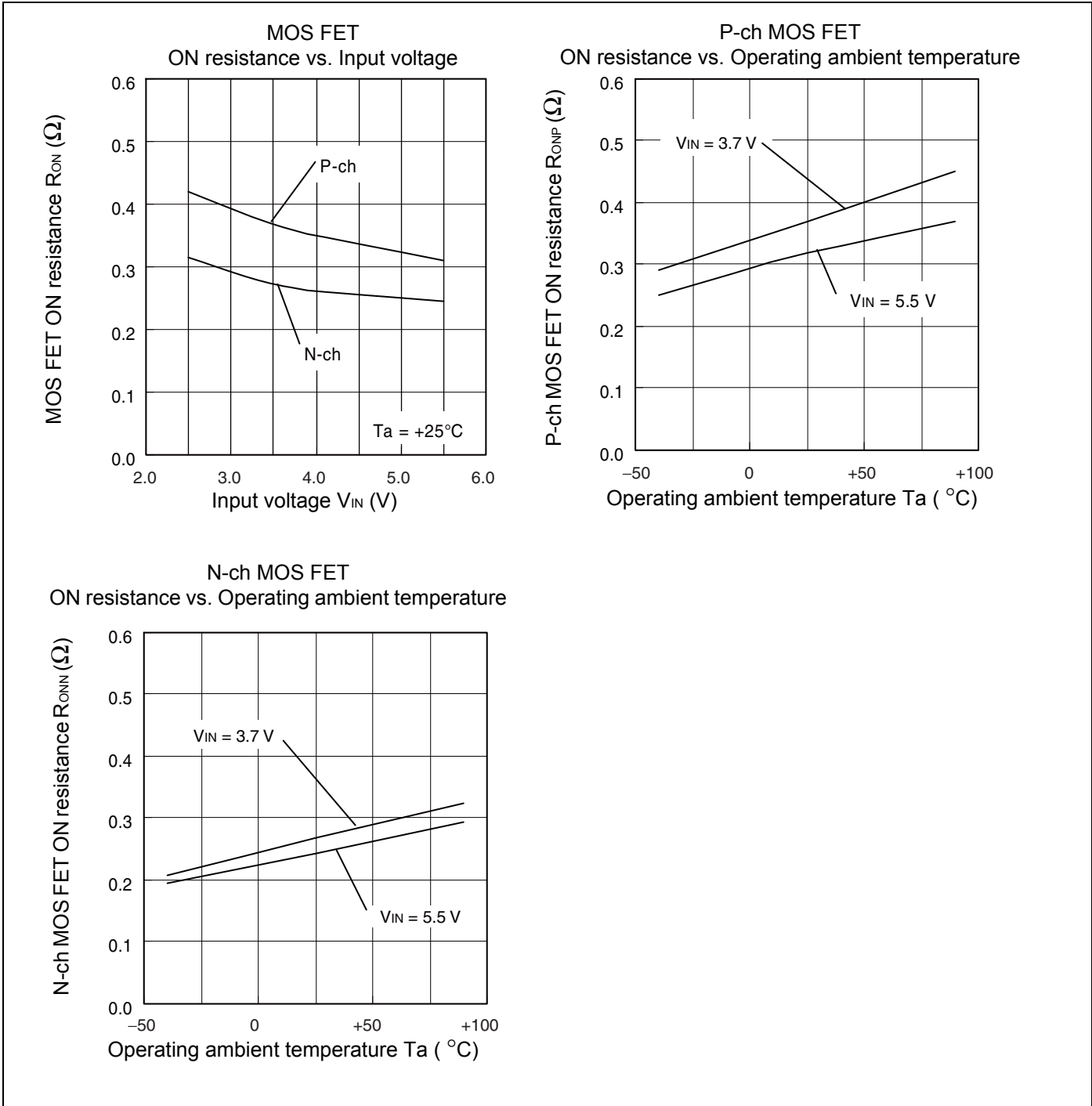

MODE V_{TH} vs. Input voltage

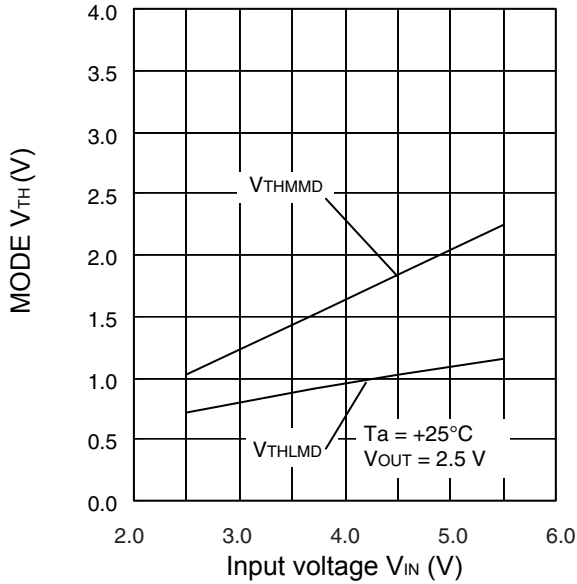

CTL V_{TH} vs. Input voltage

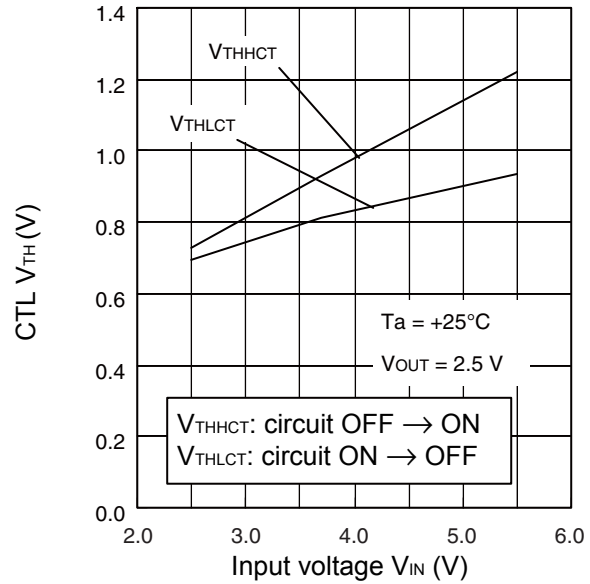

Power dissipation vs. Operating ambient temperature (with thermal via)

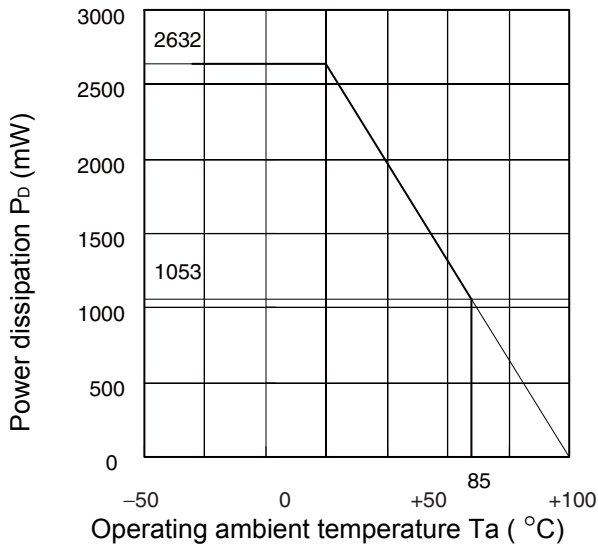

Power dissipation vs. Operating ambient temperature (without thermal via)

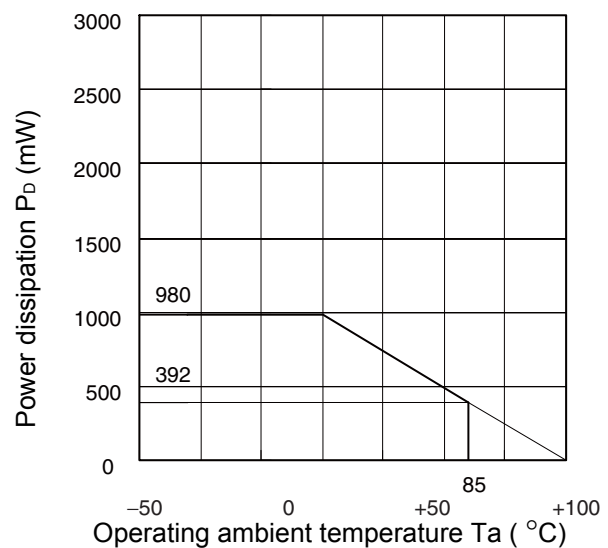

■ Switching Waveforms

● PFM/PWM operation

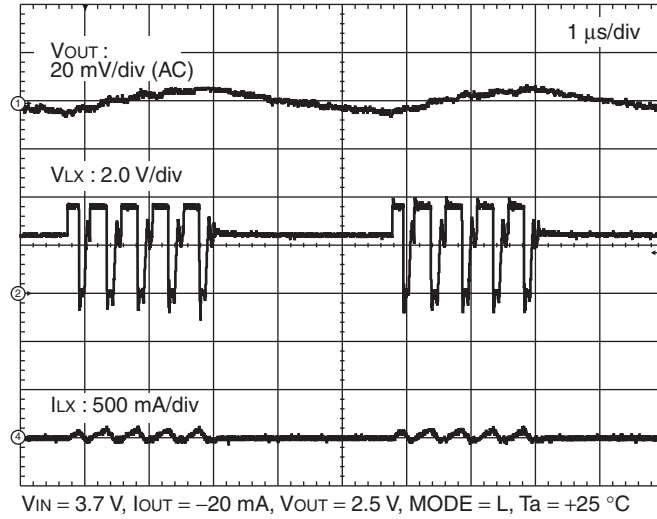

● PWM operation

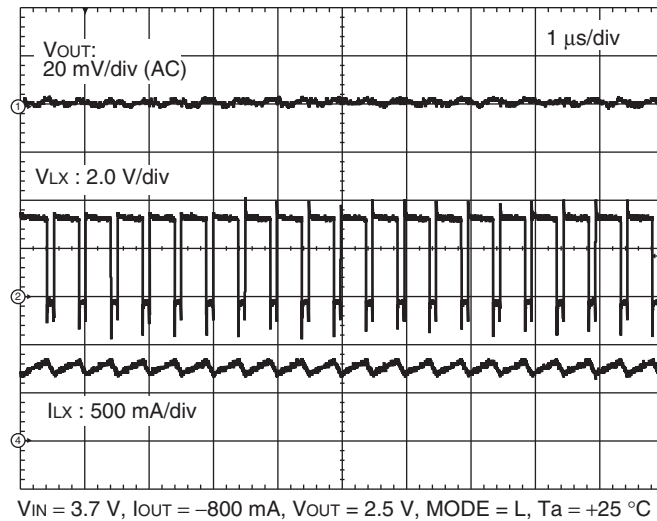

■ Output Waveforms at Sudden Load Changes (0 A ↔ - 800 mA)

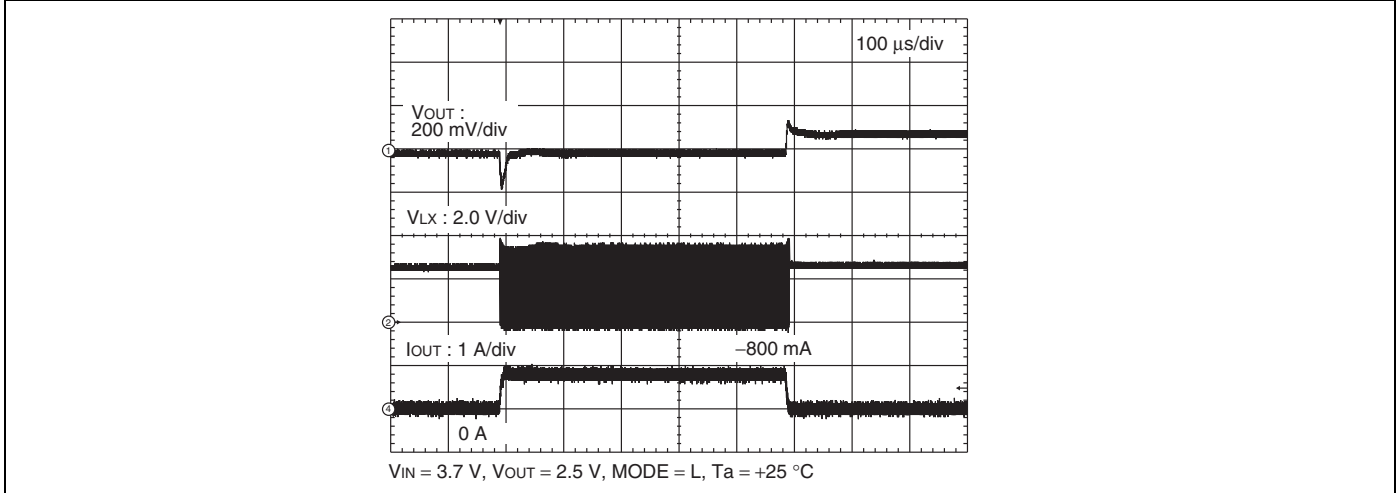

■ Output Waveforms at Sudden Load Changes (- 20 mA ↔ - 800 mA)

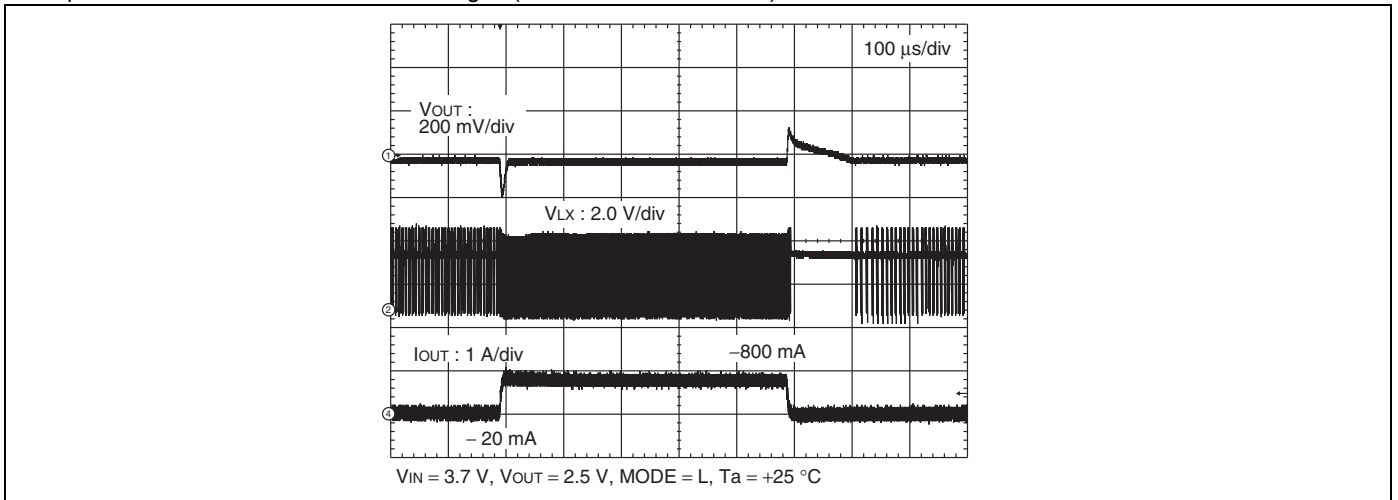

■ Output Waveforms at Sudden Load Changes (- 100 mA ↔ - 800 mA)

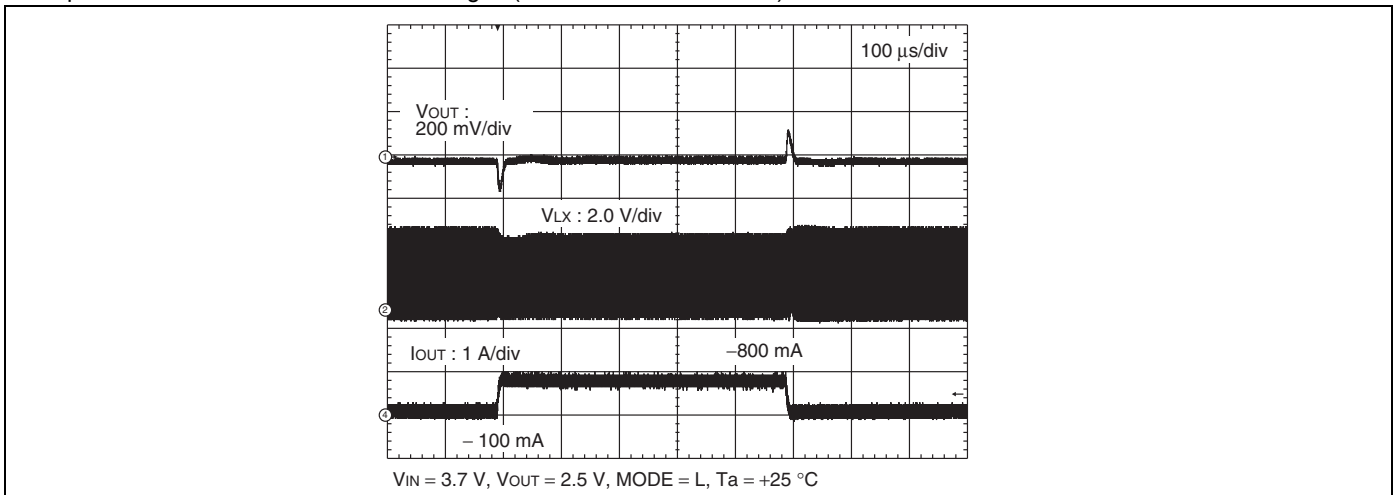

■ CTL Start-up Waveform

(No load, No VREFIN capacitor)

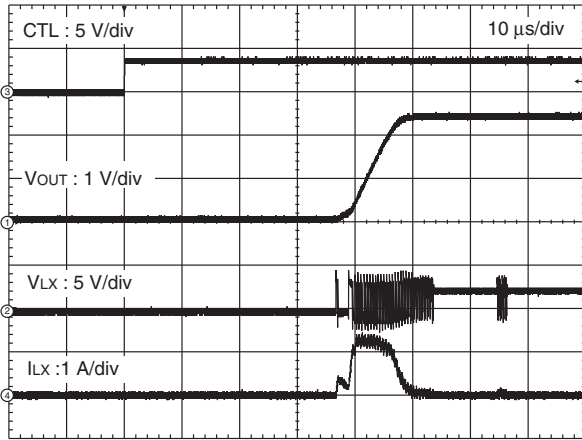

VIN = 3.7 V, IOUT = 0 A, VOUT = 2.5 V, MODE = L, Ta = +25 °C

(Maximum load, No VREFIN capacitor)

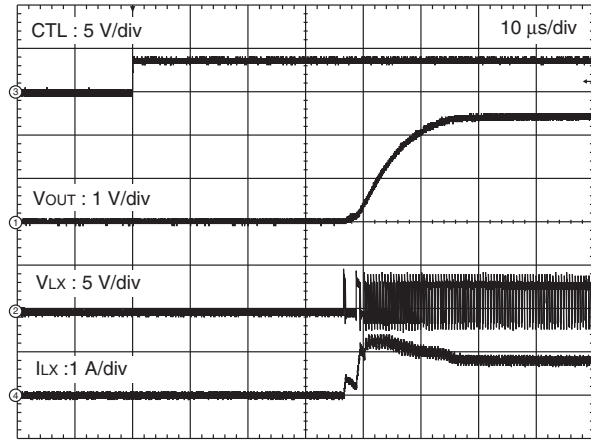

VIN = 3.7 V, IOUT = -800 mA, (3.125 Ω) VOUT = 2.5 V, MODE = L, Ta = +25 °C

(No load, VREFIN capacitor = 0.1 μF)

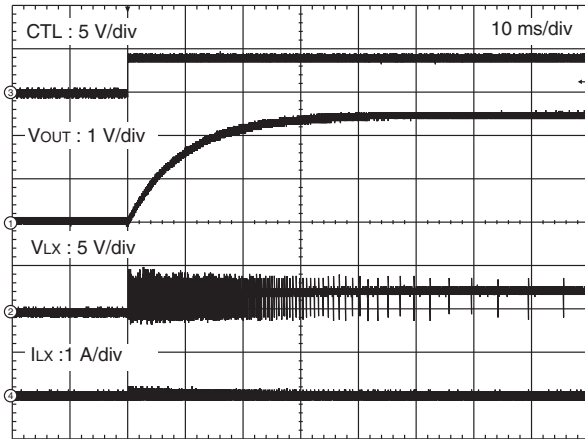

VIN = 3.7 V, IOUT = 0 A, VOUT = 2.5 V, MODE = L, Ta = +25 °C

(Maximum load, VREFIN capacitor = 0.1 μF)

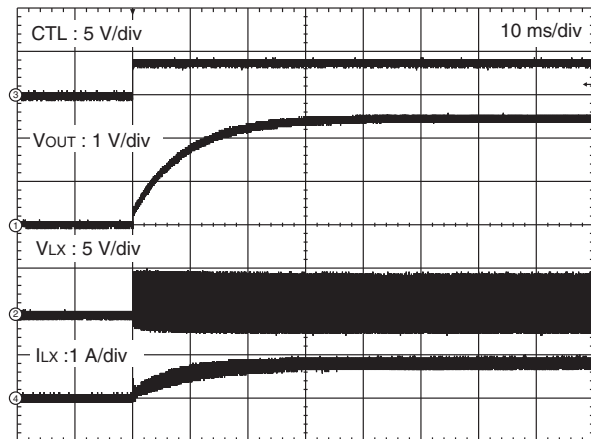

VIN = 3.7 V, IOUT = -800 mA, (3.125 Ω) VOUT = 2.5 V, MODE = L, Ta = +25 °C

■ CTL Stop Waveform (No load, VREFIN Capacitor = 0.1 μ F)

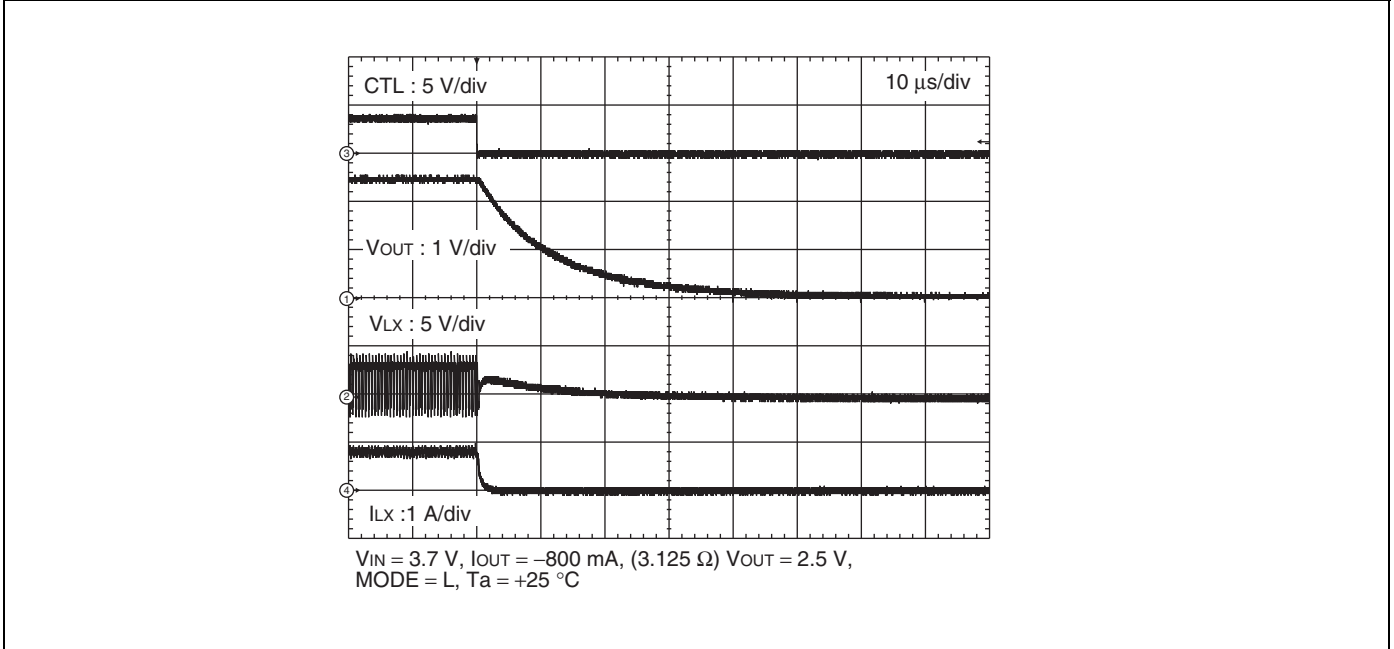

■ Current Limitation Waveform

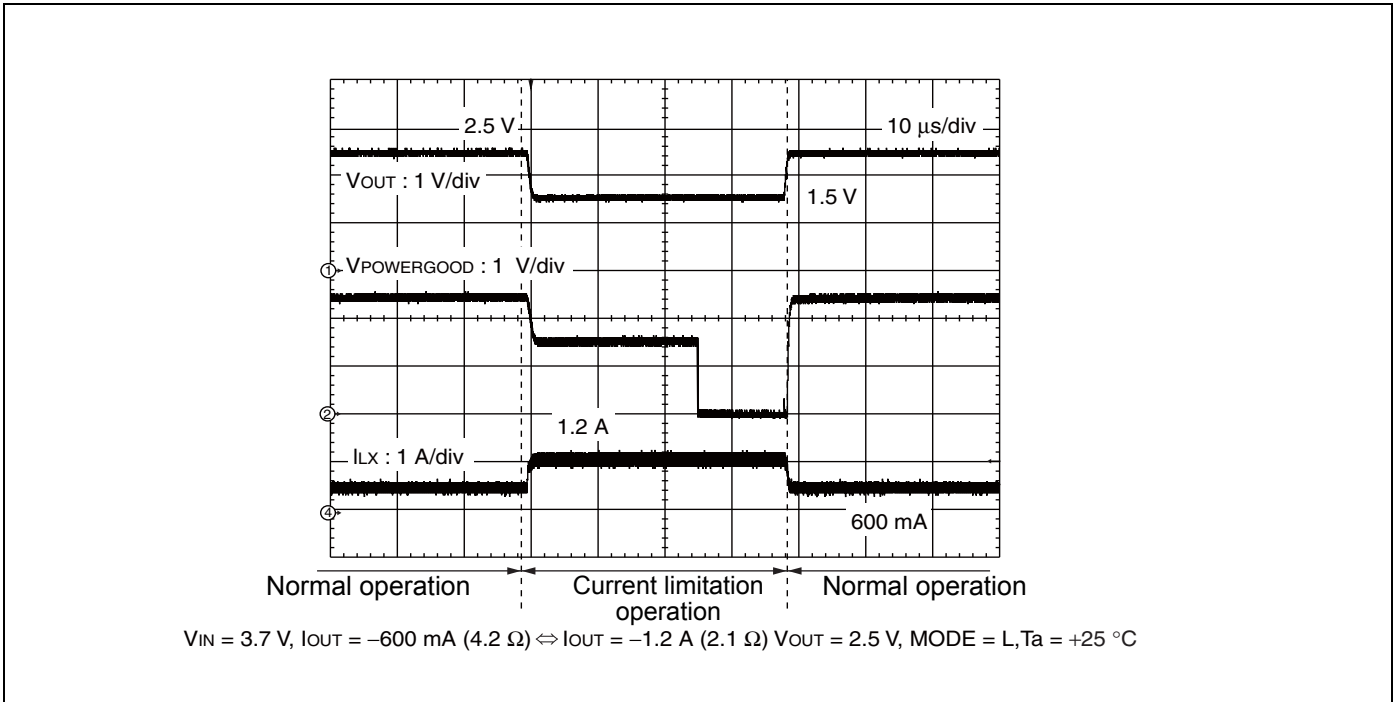

■ Waveform of Dynamic Output Voltage Transition (V_{O1} 1.8 V \leftrightarrow 2.5 V)

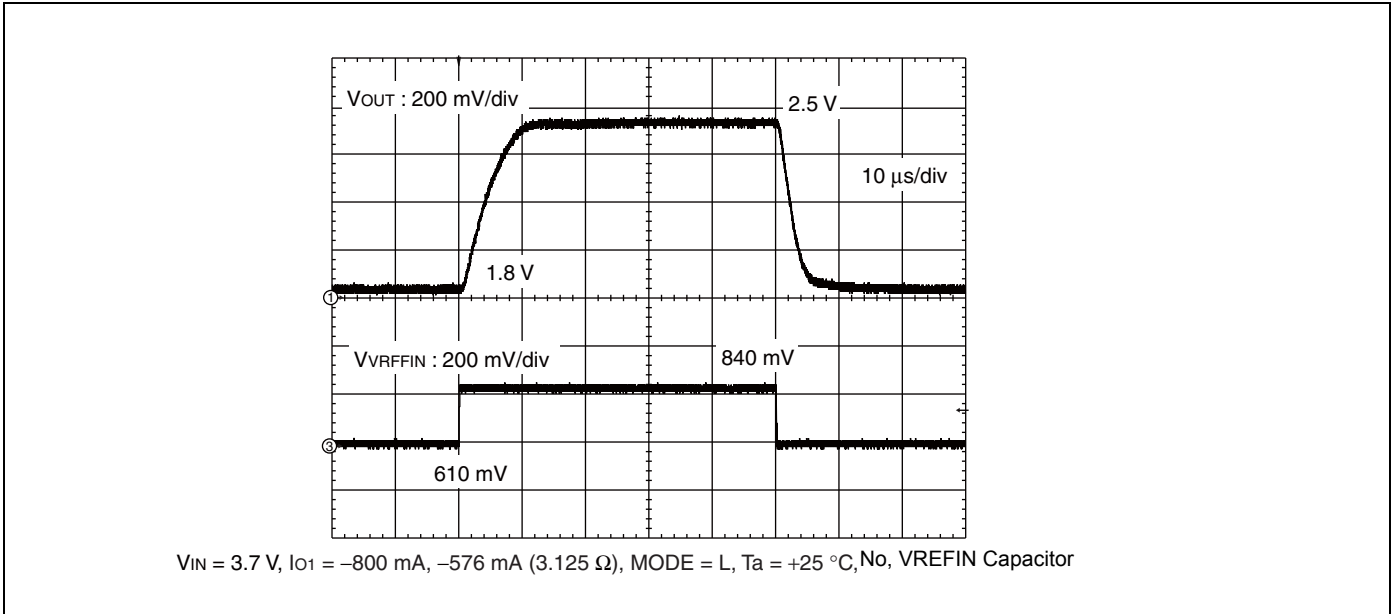

12. Application Circuit Examples

■ Application Circuit Example 1

- An external voltage is input to the reference voltage external input (V_{REFIN}), and the V_{OUT} voltage is set to 2.97 times as much as the V_{OUT} setting gain.

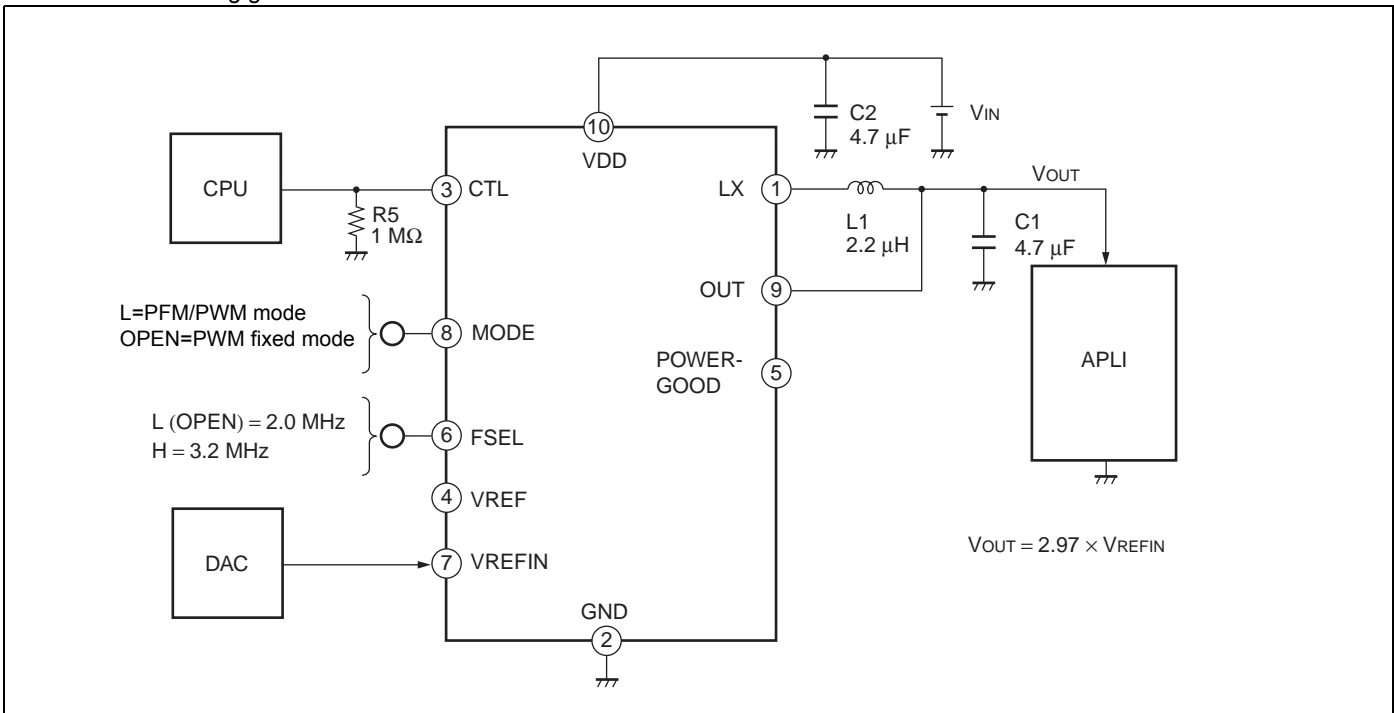

Application Circuit Example 2

- The voltage of VREF pin is input to the reference voltage external input (VREFIN) by the dividing resistors. The V_{OUT} voltage is set to 2.5 V.

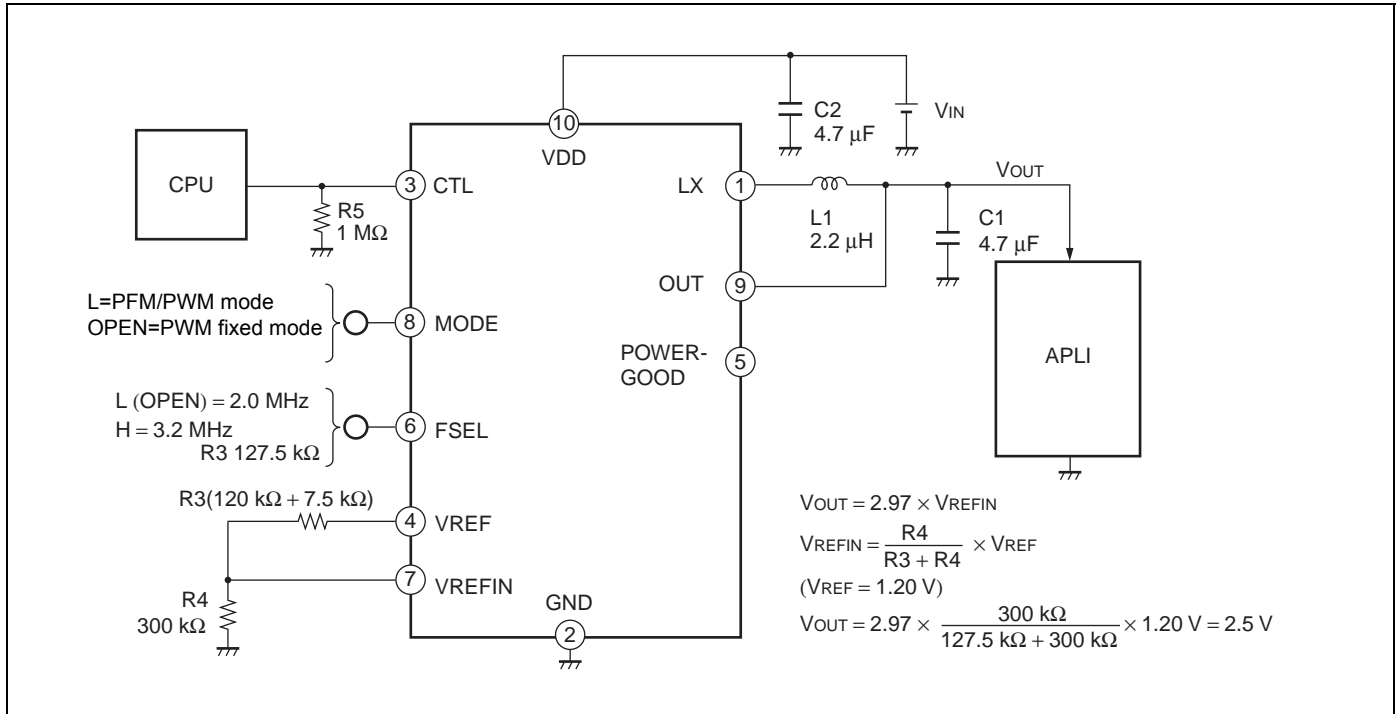
Application Circuit Example Components List

Component	Item	Part Number	Specification	Package	Vendor
L1	Inductor	VLF4012AT-2R2M	2.2 μH, RDC = 76 mΩ	SMD	TDK
		MIPW3226D2R2M	2.2 μH, RDC = 100 mΩ	SMD	FDK
C1	Ceramic capacitor	C2012JB1A475K	4.7 μF (10 V)	2012	TDK
C2	Ceramic capacitor	C2012JB1A475K	4.7 μF (10 V)	2012	TDK
R3	Resistor	RK73G1JTDD D 7.5 kΩ	7.5 kΩ	1608	KOA
		RK73G1JTDD D 120 kΩ	120 kΩ	1608	
R4	Resistor	RK73G1JTDD D 300 kΩ	300 kΩ	1608	KOA
R5	Resistor	RK73G1JTDD D	1 MΩ ± 0.5%	1608	KOA

TDK : TDK Corporation

FDK : FDK Corporation

KOA : KOA Corporation

13. Usage Precautions

1. Do not Configure the IC Over the Maximum Ratings

If the IC is used over the maximum ratings, the LSI may be permanently damaged. It is preferable for the device to normally operate within the recommended usage conditions. Usage outside of these conditions can adversely affect reliability of the LSI.

2. Use the Devices Within Recommended Operating Conditions

The recommended operating conditions are the conditions under which the LSI is guaranteed to operate. The electrical ratings are guaranteed when the device is used within the recommended operating conditions and under the conditions stated for each item.

3. Printed Circuit Board Ground Lines Should be Set Up With Consideration for Common Impedance

4. Take Appropriate Static Electricity Measures.

- Containers for semiconductor materials should have anti-static protection or be made of conductive material.
- After mounting, printed circuit boards should be stored and shipped in conductive bags or containers.
- Work platforms, tools, and instruments should be properly grounded.
- Working personnel should be grounded with resistance of 250 kΩ to 1 MΩ between body and ground.

5. Do not Apply Negative Voltages.

The use of negative voltages below – 0.3 V may create parasitic transistors on LSI lines, which can cause abnormal operation.

14. Ordering Information

Part Number	Package	Remarks
MB39C006APN	10-pin plastic SON (WNK010)	–

15. RoHS Compliance Information

The LSI products of Cypress with “E1” are compliant with RoHS Directive, and has observed the standard of lead, cadmium, mercury, hexavalent chromium, polybrominated biphenyls (PBB), and polybrominated diphenylethers (PBDE).

A product whose part number has trailing characters “E1” is RoHS compliant.

16. Package Dimension

Package Code: WNK010

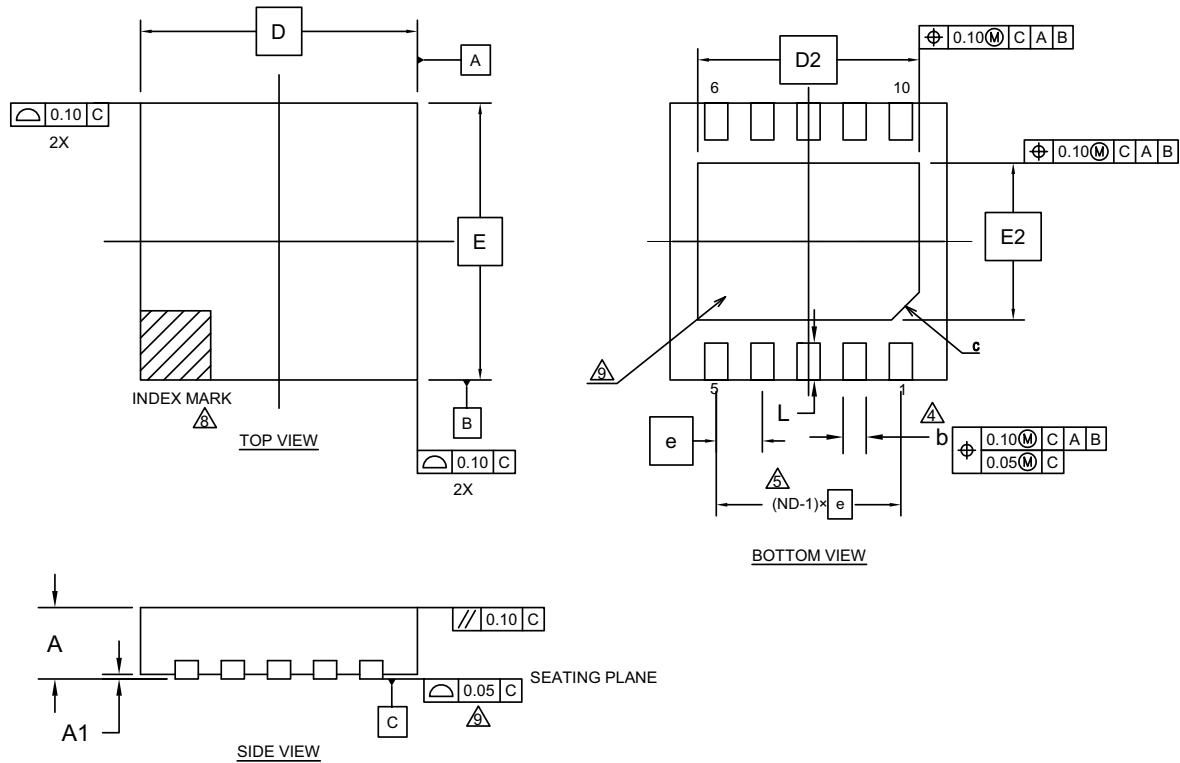

SYMBOL	MILLIMETER		
	MIN.	NOM.	MAX.
A	—	—	0.75
A1	0.00	—	0.05
D	3.00 BSC		
E	3.00 BSC		
b	0.22	0.25	0.28
D2	2.40 BSC		
E2	1.70 BSC		
e	0.50 BSC		
c	0.30 REF		
L	0.30	0.40	0.50

NOTE

- ALL DIMENSIONS ARE IN MILLIMETERS.
- DIMENSIONING AND TOLERANCING CONFORMS TO ASME Y14.5-1994.
- N IS THE TOTAL NUMBER OF TERMINALS.
- Δ DIMENSION "b" APPLIES TO METALLIZED TERMINAL AND IS MEASURED BETWEEN 0.15 AND 0.30mm FROM TERMINAL TIP. IF THE TERMINAL HAS THE OPTIONAL RADIUS ON THE OTHER END OF THE TERMINAL. THE DIMENSION "b" SHOULD NOT BE MEASURED IN THAT RADIUS AREA.
- Δ ND REFER TO THE NUMBER OF TERMINALS ON D OR E SIDE.
- MAX. PACKAGE WARPAGE IS 0.05mm.
- MAXIMUM ALLOWABLE BURRS IS 0.076mm IN ALL DIRECTIONS.
- Δ PIN #1 ID ON TOP WILL BE LOCATED WITHIN INDICATED ZONE.
- Δ BILATERAL COPLANARITY ZONE APPLIES TO THE EXPOSED HEAT SINK SLUG AS WELL AS THE TERMINALS.
- JEDEC SPECIFICATION NO. REF : N/A

002-15676 Rev. **

Document History

Spansion Publication Number: DS04-27245-2E

Document Title: MB39C006A, 1 ch DC/DC Converter IC with PFM/PWM Synchronous Rectification Document Number: 002-09201				
Revision	ECN	Orig. of Change	Submission Date	Description of Change
**	-	TAOA	11/21/2008	Migrated to Cypress and assigned document number 002-09201. No change to document contents or format.
*A	5518137	TAOA	11/11/2016	Updated to Cypress template
*B	5632018	HIXT	02/15/2017	Updated Pin Assignment : Change the package name from LCC-10P-M04 to WNK010 Updated Ordering Information : Change the package name from LCC-10P-M04 to WNK010 Deleted "Labeling Sample (Lead Free Version)" Deleted "Marking Format" Deleted "Recommended Mounting Conditions of MB39C006APN" Deleted "Evaluation Board Specification" Deleted "EV Board Ordering Information" Updated Package Dimension : Updated to Cypress format

Sales, Solutions, and Legal Information

Worldwide Sales and Design Support

Cypress maintains a worldwide network of offices, solution centers, manufacturer's representatives, and distributors. To find the office closest to you, visit us at [Cypress Locations](#).

Products

ARM® Cortex® Microcontrollers	cypress.com/arm
Automotive	cypress.com/automotive
Clocks & Buffers	cypress.com/clocks
Interface	cypress.com/interface
Internet of Things	cypress.com/iot
Memory	cypress.com/memory
Microcontrollers	cypress.com/mcu
PSoC	cypress.com/psoc
Power Management ICs	cypress.com/pmic
Touch Sensing	cypress.com/touch
USB Controllers	cypress.com/usb
Wireless/RF	cypress.com/wireless

PSoC® Solutions

[PSoC 1](#) | [PSoC 3](#) | [PSoC 4](#) | [PSoC 5LP](#)

Cypress Developer Community

[Forums](#) | [WICED IOT Forums](#) | [Projects](#) | [Video](#) | [Blogs](#) | [Training](#) | [Components](#)

Technical Support

cypress.com/support

© Cypress Semiconductor Corporation, 2008-2017. This document is the property of Cypress Semiconductor Corporation and its subsidiaries, including Spansion LLC ("Cypress"). This document, including any software or firmware included or referenced in this document ("Software"), is owned by Cypress under the intellectual property laws and treaties of the United States and other countries worldwide. Cypress reserves all rights under such laws and treaties and does not, except as specifically stated in this paragraph, grant any license under its patents, copyrights, trademarks, or other intellectual property rights. If the Software is not accompanied by a license agreement and you do not otherwise have a written agreement with Cypress governing the use of the Software, then Cypress hereby grants you a personal, non-exclusive, nontransferable license (without the right to sublicense) (1) under its copyright rights in the Software (a) for Software provided in source code form, to modify and reproduce the Software solely for use with Cypress hardware products, only internally within your organization, and (b) to distribute the Software in binary code form externally to end users (either directly or indirectly through resellers and distributors), solely for use on Cypress hardware product units, and (2) under those claims of Cypress's patents that are infringed by the Software (as provided by Cypress, unmodified) to make, use, distribute, and import the Software solely for use with Cypress hardware products. Any other use, reproduction, modification, translation, or compilation of the Software is prohibited.

TO THE EXTENT PERMITTED BY APPLICABLE LAW, CYPRESS MAKES NO WARRANTY OF ANY KIND, EXPRESS OR IMPLIED, WITH REGARD TO THIS DOCUMENT OR ANY SOFTWARE OR ACCOMPANYING HARDWARE, INCLUDING, BUT NOT LIMITED TO, THE IMPLIED WARRANTIES OF MERCHANTABILITY AND FITNESS FOR A PARTICULAR PURPOSE. To the extent permitted by applicable law, Cypress reserves the right to make changes to this document without further notice. Cypress does not assume any liability arising out of the application or use of any product or circuit described in this document. Any information provided in this document, including any sample design information or programming code, is provided only for reference purposes. It is the responsibility of the user of this document to properly design, program, and test the functionality and safety of any application made of this information and any resulting product. Cypress products are not designed, intended, or authorized for use as critical components in systems designed or intended for the operation of weapons, weapons systems, nuclear installations, life-support devices or systems, other medical devices or systems (including resuscitation equipment and surgical implants), pollution control or hazardous substances management, or other uses where the failure of the device or system could cause personal injury, death, or property damage ("Unintended Uses"). A critical component is any component of a device or system whose failure to perform can be reasonably expected to cause the failure of the device or system, or to affect its safety or effectiveness. Cypress is not liable, in whole or in part, and you shall and hereby do release Cypress from any claim, damage, or other liability arising from or related to all Unintended Uses of Cypress products. You shall indemnify and hold Cypress harmless from and against all claims, costs, damages, and other liabilities, including claims for personal injury or death, arising from or related to any Unintended Uses of Cypress products.

Cypress, the Cypress logo, Spansion, the Spansion logo, and combinations thereof, WICED, PSoC, CapSense, EZ-USB, F-RAM, and Traveo are trademarks or registered trademarks of Cypress in the United States and other countries. For a more complete list of Cypress trademarks, visit cypress.com. Other names and brands may be claimed as property of their respective owners..