

CONNECTOR SPECIFICATION:

VOLTAGE RATING	250 VAC/VDC
AMPERAGE RATING	max. 4 AMPS
PROTECTION	IP67
OPERATING TEMPERATURE	-20°C TO 80°C
UL CERTIFICATIONS	UL RECOGNIZED, FILE NO. E152210
CSA CERTIFICATIONS	LR6837

ITEM	COMPONENT	MATERIAL	FINISH
7	LABLE	MYLAR	BLACK/YELLOW
6	COUPLER	BRASS	NICKEL PLATED
5	O-RING	VITON	RED
4	SOCKET/PIN CONTACT	COPPER ALLOY	GOLD OVER NICKEL
3	INSERT	NYLON	BLACK
2	OVERMOLD	TPE	YELLOW
1	CABLE- 22/3-5 (COPPER STRANDING) 3/4/5 CONDUCT. 300V	TPE JACKET	YELLOW

DESCRIPTION EC NO.: WEU2010-0288 DRWN: LSTEMMLE 2010/01/25 CHKD: NS APPR: NSTAUDIG 2010/01/29	QUALITY SYMBOLS ▽ = 0 ▽/C = 0	GENERAL TOLERANCES (UNLESS SPECIFIED) mm INCH 4 PLACES ±--- ±--- 3 PLACES ±--- ±--- 2 PLACES ±--- ±.01 1 PLACE ±0.3 ±--- ANGULAR ± --- °	DIMENSION STYLE IN/MM DRAWN BY DATE LSTEMMLE 2010/01/25 CHECKED BY DATE RE 2010/01/26 APPROVED BY DATE NSTAUDIG 2010/01/29	SCALE 2:1 DESIGN UNITS METRIC THIRD ANGLE PROJECTION	MICRO-CHANGE CORDSET 3/4/5 P. FE STR/ MA STR 18/3-5 YELLOW TPE CABLE	
	DRAFT WHERE APPLICABLE MUST REMAIN WITHIN DIMENSIONS		SEE TABLE	MATERIAL NO. SD-120066-012	SHEET NO. 1 OF 1	
	SIZE A3		THIS DRAWING CONTAINS INFORMATION THAT IS PROPRIETARY TO MOLEX INCORPORATED AND SHOULD NOT BE USED WITHOUT WRITTEN PERMISSION			
	MOLEX INCORPORATED					

POL	MATERIAL NUMBER	ENGINEERING NUMBER	FINISHED LENGTH
4	1200660854	884030B02M010	1.0M +55.6 -0 [3.27' +2.19" -0]
4	1200660856	884030B02M015	1.5M +55.6 -0 [4.91' +2.19" -0]
4	1200660857	884030B02M020	2.0M +88.9 -0 [6.56' +3.50" -0]
4	1200660859	884030B02M020	2.5M +88.9 -0 [8.18' +3.50" -0]
4	1200660860	884030B02M030	3.0M +88.9 -0 [9.84' +3.50" -0]
4	1200660861	884030B02M040	4.0M +165.1 -0 [13.12' +6.50" -0]
4	1200660862	884030B02M050	5.0M +165.1 -0 [16.40' +6.50" -0]
4	1200660864	884030B02M060	6.0M +165.1 -0 [19.69' +6.50" -0]
4	1200660865	884030B02M070	7.0M +165.1 -0 [22.96' +6.50" -0]
4	1200660866	884030B02M080	8.0M +317.5 -0 [26.25' +12.50" -0]
4	1200660867	884030B02M100	10.0M +317.5 -0 [32.81' +12.50" -0]

DESCRIPTION EC NO.: WEU2010-0288 DRWN: LSTEMMLE 2010/01/25 CH'KD: NS APPR: NSTAUDIG 2010/01/29	QUALITY SYMBOLS	GENERAL TOLERANCES (UNLESS SPECIFIED)		DIMENSION STYLE		SCALE	DESIGN UNITS	THIRD ANGLE PROJECTION	
	 	mm	INCH	IN/MM		2:1	METRIC		
		4 PLACES ±---	±---	DRAWN BY DATE				MICRO-CHANGE CORDSET 3/4/5 P. FE STR/ MA STR 18/3-5 YELLOW TPE CABLE	
	3 PLACES ±---	±---	LSTEMMLE 2010/01/25						
		2 PLACES ±---	±.01	CHECKED BY DATE				MOLEX INCORPORATED	
	1 PLACE ±0.3	±---	RE 2010/01/26						
	ANGULAR ± --- °		APPROVED BY DATE				MATERIAL NO. SD-120066-012 SHEET NO. 1 OF 1		
			DRAFT WHERE APPLICABLE MUST REMAIN WITHIN DIMENSIONS		SEE TABLE		THIS DRAWING CONTAINS INFORMATION THAT IS PROPRIETARY TO MOLEX INCORPORATED AND SHOULD NOT BE USED WITHOUT WRITTEN PERMISSION		

M12 FEMALE

FACE VIEWS

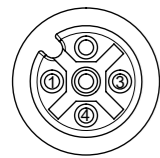

PIN	WIRE COLOR
1	BROWN
2	-
3	BLUE
4	BLACK

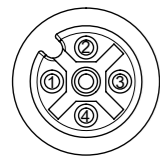

PIN	WIRE COLOR
1	BROWN
2	WHITE
3	BLUE
4	BLACK

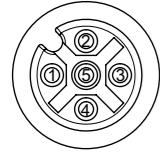

PIN	WIRE COLOR
1	BROWN
2	WHITE
3	BLUE
4	BLACK
5	GY or GN-YE

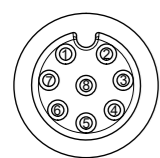

PIN	WIRE COLOR
1	WHITE
2	BROWN
3	GREEN
4	YELLOW
5	GREY
6	PINK
7	BLUE
8	RED

M12 MALE

FACE VIEWS



PIN	WIRE COLOR
1	BROWN
2	-
3	BLUE
4	BLACK



PIN	WIRE COLOR
1	BROWN
2	WHITE
3	BLUE
4	BLACK



PIN	WIRE COLOR
1	BROWN
2	WHITE
3	BLUE
4	BLACK
5	GY or GN-YE

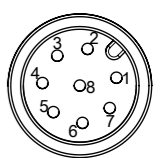

PIN	WIRE COLOR
1	WHITE
2	BROWN
3	GREEN
4	YELLOW
5	GREY
6	PINK
7	BLUE
8	RED

FEMALE STRAIGHT - MALE STRAIGHT
88X030BXXMXXX

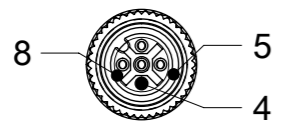

FEMALE RIGHT ANGEL - MALE STRAIGHT
88X031BXXMXXX

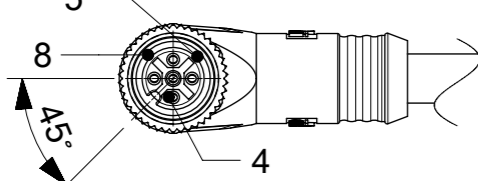

FEMALE STRAIGHT - MALE RIGHT ANGEL
88X032BXXMXXX

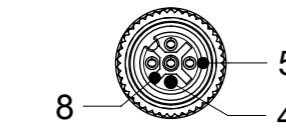

FEMALE RIGHT ANGLE - MALE RIGHT ANGLE
88X033BXXMXXX

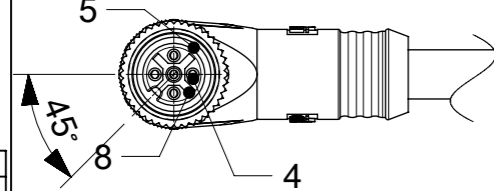

VIEW FROM THE FRONT SIDE
FEMALE 5P

VIEW FROM THE FRONT SIDE
MALE 5P

L + TOL. - SEE MATRIX
(SHEET 2)

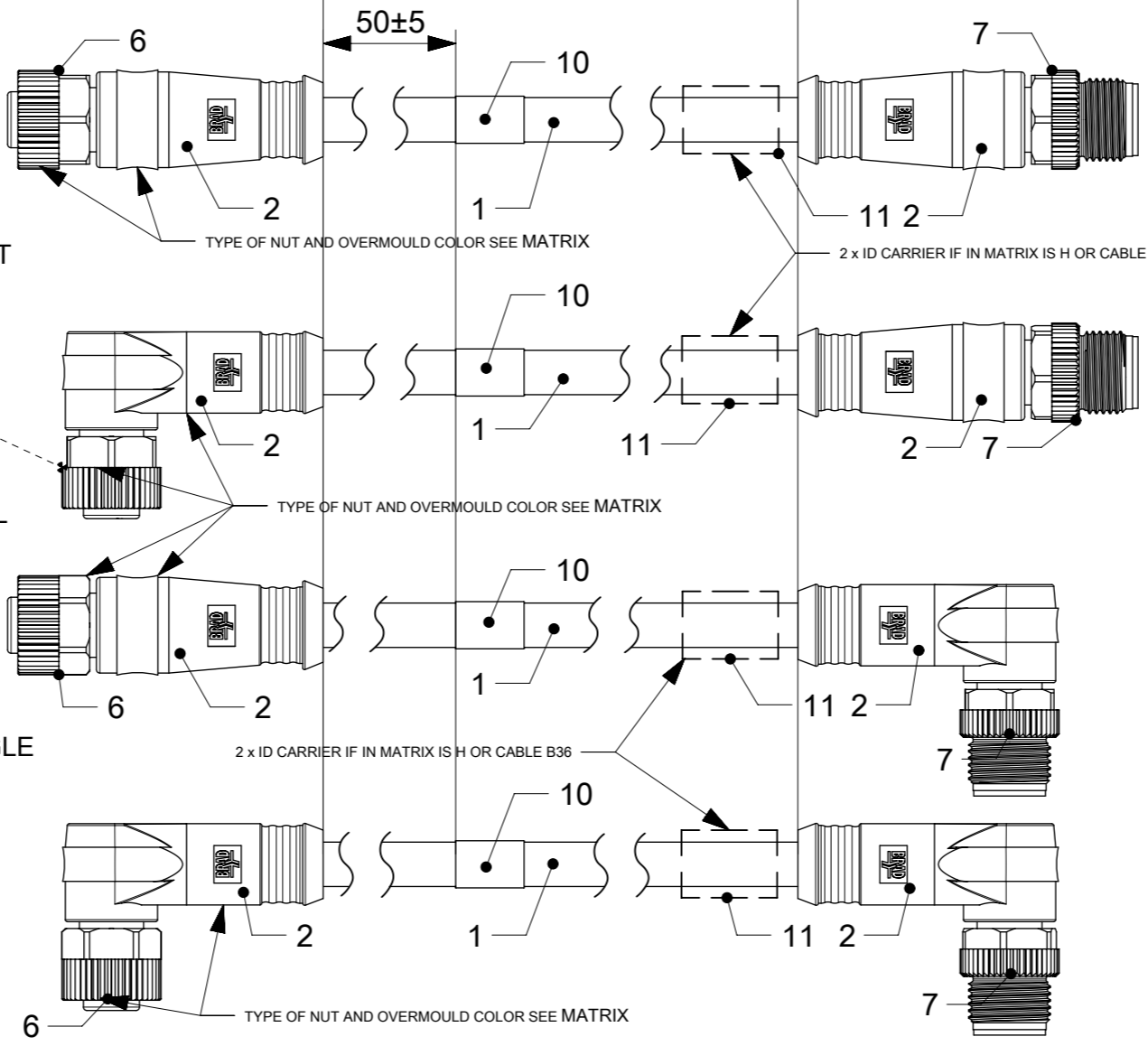

BILL OF MATERIALS

ITEM	QTY.	DESCRIPTION	MATERIAL	FINISH
11	X	ID CARRIER (SEE MATRIX)	PVC	-
10	1	STANDARD WRAP LABEL YE	VINYL	-
9	1	INSERT M12 MA XP BK	ELASTOLLAN	-
8	1	INSERT M12 FE XP BK	ELASTOLLAN	-
7	1	NUT M12 MA HEX	BRASS	NICKEL PLATED
6	1	NUT M12 FE HEX	BRASS	NICKEL PLATED
5	1	GASKET RD	FPM	-
4	X	CONTACT FEMALE	BRONZE	GOLD OVER NICKEL PLATED
3	X	CONTACT MALE	CuNi2Si	GOLD OVER NICKEL PLATED
2	-	MOULDING MATERIAL	TPU	-
1	-	CABLE (SEE MATRIX)	-	-

NOTE:

1. BRAD LOGO - ONLY IN ONE SIDE ON THE OVERMOULD.

THIS DRAWING CONTAINS INFORMATION THAT IS PROPRIETARY TO MOLEX ELECTRONIC TECHNOLOGIES, LLC AND SHOULD NOT BE USED WITHOUT WRITTEN PERMISSION

EC NO: 107719 DRWN: MMATLA CHK'D: MIWASIECZKO APPR: MIWASIECZKO	2016/06/23 2016/08/22	GENERAL TOLERANCES (UNLESS SPECIFIED) ANGULAR TOL ± °	DIMENSION UNITS: MM SCALE: 1:1		
	4 PLACES ± 3 PLACES ± 2 PLACES ± 1 PLACE ± 0 PLACES ±	DRWN BY: MMATLA DATE: 2016/06/23	DRWN BY: MMATLA DATE: 2016/06/23		CSE M12 XP AC FE XXX TPU MA XXX XM DE
	DRAFT WHERE APPLICABLE MUST REMAIN WITHIN DIMENSIONS	APPR BY: MIWASIECZKO DATE: 2016/08/22	APPR BY: MIWASIECZKO DATE: 2016/08/22		
	A3 	DRAWING SIZE: A3 THIRD ANGLE PROJECTION	SERIES: 120065 MATERIAL NUMBER: SEE MATRIX (SH 2)		CUSTOMER:
A REV	1200659548	DOCUMENT NUMBER: 1200659548	DOC TYPE: PSD DOC PART: 00P SHEET NUMBER: 1 OF 4	A	

PART No MATRIX - NUMERICAL CODE (AVAILABLE PARTS SEE PART LIST TABLE. OTHERS PARTS AVAILABLE UPON REQUEST).

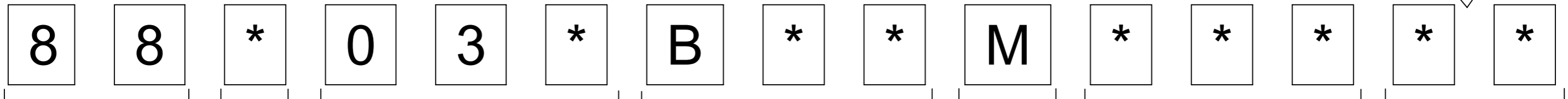

88 = M12x2

POLES:
 3 = 3 POLES
 4 = 4 POLES
 5 = 5POLES
 8 = POLES

HEADER:
 030 = FEMALE STRAIGHT / MALE STRAIGHT
 031 = FEMALE RIGHT ANGEL / MALE STRAIGHT
 032 = FEMALE STRAIGHT/ MALE RIGHT ANGEL
 033 = FEMALE RIGHT ANGLE / MALE RIGHT ANGLE

CABLE:
 B30 = 0.34mm², TPU BLACK
 B33 = 0.34mm², TPU GREY
 B36 = 0.34mm², TPU ORANGE
 B41 = 0.25mm², TPU BLACK
 B42 = 0.34mm², TPU BLACK
 B49 = 0.25mm², TPU ORANGE

UNITS:
 M = METER
 C = CENTIMETER
 T = 10 x METER

LENGTH:
EXAMPLES:
 010 = 1 UNITS
 050 = 5 UNITS
 150 = 15 UNITS

H = 2 SZT. I/D CARRIER
COUPLIN NUT:
 BLANK = KNU / HEX
 7 = TEFLON KNU
 5 = PLASTIC NYLON
OVERMOULD:
 BLANK = BLACK
 A = GREY
 G = BLACK
 Y = YELLOW

88X030B33MXXXXX		
MOLEX PN	ENGINEERING No	CABLE LENGTH [mm]
1200669223	884030B33M010	1000
1200669224	884030B33M020	2000
1200669225	884030B33M030	3000
1200669226	884030B33M050	5000
1200669247	885030B33M020	2000
1200669248	885030B33M100	10000
1200669249	885030B33M200	20000
1200669250	884030B33M005	500
1200669251	884030B33M100	10000
1200669252	884030B33M200	20000
1200669253	885030B33M030	3000
1200669254	885030B33M050	5000
1200669255	885030B33M300	30000
1200669256	884030B33M300	30000
1200669257	885030B33M005	500
1200669258	885030B33M010	1000

88X030B41MXXXXX		
MOLEX PN	ENGINEERING No	CABLE LENGTH [mm]
1200668870	888030B41M038	3800
1200668895	888030B41M006	600
1200668896	888030B41M010	1000
1200668897	888030B41M020	2000
1200668898	888030B41M030	3000
1200668899	888030B41M050	5000
1200668900	888030B41M100	10000
1200669177	888030B41M090	9000

88X030B42MXXXXX		
MOLEX PN	ENGINEERING No	CABLE LENGTH [mm]
1200659548	885030B42M150	15000
1200659549	885030B42M200	20000
1200668823	885030B42M006	600
1200668824	885030B42M010	1000
1200668825	885030B42M020	2000
1200668826	885030B42M030	3000
1200668827	885030B42M050	5000
1200668828	885030B42M100	10000

88X030B49MXXXXX		
MOLEX PN	ENGINEERING No	CABLE LENGHT [mm]
1200669017	888030B49M015Y	1500
1200669112	888030B49M038Y	3800

TABLE OF LENGTH TOLERANCES		
OVER	UP TO AND INCLUDING	TOLERANCE
0	1000	+40 0
1000	5000	+60 0
5000	10000	+80 0
10000	20000	+140 0
20000	30000	+160 0
30000	>	+1% OF LENGTH

THIS DRAWING CONTAINS INFORMATION THAT IS PROPRIETARY TO MOLEX ELECTRONIC TECHNOLOGIES, LLC AND SHOULD NOT BE USED WITHOUT WRITTEN PERMISSION

EC NO: 107719 DRWN: MMATLA CHK'D: MIWASIECZKO REV APPR: MIWASIECZKO	2016/06/23	2016/08/22	GENERAL TOLERANCES (UNLESS SPECIFIED)	DIMENSION UNITS	SCALE			
			ANGULAR TOL ± °	MM	1:1			
			4 PLACES ±	DRWN BY	DATE			
			3 PLACES ±	MMATLA	2016/06/23			
		2 PLACES ±	CHK'D BY	DATE	CSE M12 XP AC FE XXX TPU MA XXX XM DE PRODUCT CUSTOMER DRAWING			
		1 PLACE ±	APPR BY	DATE				
		0 PLACES ±	MIWASIECZKO	2016/08/22				
		DRAFT WHERE APPLICABLE MUST REMAIN WITHIN DIMENSIONS	DRAWING SIZE	THIRD ANGLE PROJECTION	SERIES	MATERIAL NUMBER	CUSTOMER	
			A3		120065	SEE MATRIX		
					DOCUMENT NUMBER	DOC TYPE	DOC PART	SHEET NUMBER
					1200659548	PSD	00P	2 OF 4

88X030B30MXXXXX		
MOLEX PN	ENGINEERING No	CABLE LENGTH [mm]
1200659666	885030B30M005	500
1200659667	885030B30M025	2500
1200668817	884030B30M006	600
1200668818	884030B30M010	1000
1200668819	884030B30M020	2000
1200668820	884030B30M030	3000
1200668821	884030B30M050	5000
1200668822	884030B30M100	10000
1200668863	884030B30M070	7000
1200668889	883030B30M006	600
1200668890	883030B30M010	1000
1200668891	883030B30M020	2000
1200668892	883030B30M030	3000
1200668893	883030B30M050	5000
1200668894	883030B30M100	10000
1200668913	884030B30M150	15000
1200668914	884030B30M200	20000
1200668915	884030B30M250	25000
1200668916	884030B30M300	30000
1200668991	885030B30M006	600
1200668992	885030B30M010	1000
1200668993	885030B30M020	2000
1200668994	885030B30M030	3000
1200668995	885030B30M050	5000
1200668996	885030B30M100	10000
1200669142	884030B30M0105	1000
1200669143	884030B30M0505	5000
1200669144	884030B30M025	2500
1200669145	885030B30M015	1500
1200669157	884030B30M002	200
1200669181	884030B30M040	4000
1200669182	884030B30M060	6000
1200669242	885030B30M0107	1000

88X030B36MXXXXX		
MOLEX PN	ENGINEERING No	CABLE LENGTH [mm]
1200668859	884030B36M0507Y	5000
1200668860	884030B36M1007Y	10000
1200669019	884030B36M0057Y	500
1200669020	884030B36M0107Y	1000
1200669021	884030B36M0157Y	1500
1200669022	884030B36M0207Y	2000
1200669023	884030B36M0307Y	3000
1200669024	884030B36M0407Y	4000
1200669025	884030B36M0607Y	6000
1200669026	884030B36M0807Y	8000
1200669027	884030B36M1207Y	12000
1200669028	884030B36M1507Y	15000
1200669029	884030B36M2007Y	20000
1200669030	884030B36M2507Y	25000
1200669031	884030B36M3007Y	30000
1200669032	885030B36M0057Y	500
1200669033	885030B36M0107Y	1000
1200669034	885030B36M0207Y	2000
1200669035	885030B36M0307Y	3000
1200669036	885030B36M0407Y	4000
1200669037	885030B36M0507Y	5000
1200669038	885030B36M0607Y	6000
1200669039	885030B36M0807Y	8000
1200669040	885030B36M1007Y	10000
1200669041	885030B36M1207Y	12000
1200669042	885030B36M1507Y	15000
1200669043	885030B36M1807Y	18000
1200669044	885030B36M2007Y	20000
1200669045	885030B36M2507Y	25000
1200669046	885030B36M3007Y	30000
1200669140	885030B36M8507Y	85000

88X031B30MXXXXX		
MOLEX PN	ENGINEERING No	CABLE LENGTH [mm]
1200668829	884031B30M006	600
1200668830	884031B30M010	1000
1200668831	884031B30M020	2000
1200668832	884031B30M030	3000
1200668833	884031B30M050	5000
1200668834	884031B30M100	10000
1200668877	883031B30M006	600
1200668878	883031B30M010	1000
1200668879	883031B30M020	2000
1200668880	883031B30M030	3000
1200668881	883031B30M050	5000
1200668882	883031B30M100	10000
1200668997	885031B30M006	600
1200668998	885031B30M010	1000
1200668999	885031B30M020	2000
1200669000	885031B30M030	3000
1200669001	885031B30M050	5000
1200669002	885031B30M100	10000
1200669241	885031B30M0067	600
1200669243	885031B30M0207	2000

88X031B41MXXXXX		
MOLEX PN	ENGINEERING No	CABLE LENGTH [mm]
1200668883	888031B41M006	600
1200668884	888031B41M010	1000
1200668885	888031B41M020	2000
1200668886	888031B41M030	3000
1200668887	888031B41M050	5000
1200668888	888031B41M100	10000

88X031B42MXXXXX		
MOLEX PN	ENGINEERING No	CABLE LENGTH [mm]
1200668835	885031B42M006	600
1200668836	885031B42M010	1000
1200668837	885031B42M020	2000
1200668838	885031B42M030	3000
1200668839	885031B42M050	5000
1200668840	885031B42M100	10000

88X031B36MXXXXX		
MOLEX PN	ENGINEERING No	CABLE LENGTH [mm]
1200668861	884031B36M0507Y	5000
1200668862	884031B36M1007Y	10000
1200669047	884031B36M0057Y	500
1200669048	884031B36M0107Y	1000
1200669049	884031B36M0157Y	1500
1200669050	884031B36M0207Y	2000
1200669051	884031B36M0307Y	3000
1200669052	884031B36M0407Y	4000
1200669053	884031B36M0607Y	6000
1200669054	884031B36M0807Y	8000
1200669055	884031B36M1207Y	12000
1200669056	884031B36M1507Y	15000
1200669057	884031B36M2007Y	20000
1200669058	884031B36M2507Y	25000
1200669059	884031B36M3007Y	30000
1200669060	885031B36M0057Y	500
1200669061	885031B36M0107Y	1000
1200669062	885031B36M0207Y	2000
1200669063	885031B36M0307Y	3000
1200669064	885031B36M0407Y	4000
1200669065	885031B36M0507Y	5000
1200669066	885031B36M0607Y	6000
1200669067	885031B36M0807Y	8000
1200669068	885031B36M1007Y	10000
1200669069	885031B36M1207Y	12000
1200669070	885031B36M1507Y	15000
1200669071	885031B36M1807Y	18000
1200669072	885031B36M2007Y	20000
1200669073	885031B36M2507Y	25000
1200669074	885031B36M3007Y	30000

RELEASE STATUS	P1	RELEASE DATE	22.08.2016	11:01:26
----------------	----	--------------	------------	----------

THIS DRAWING CONTAINS INFORMATION THAT IS PROPRIETARY TO MOLEX ELECTRONIC TECHNOLOGIES, LLC AND SHOULD NOT BE USED WITHOUT WRITTEN PERMISSION

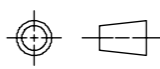
2016/06/23	2016/08/22	GENERAL TOLERANCES (UNLESS SPECIFIED)	DIMENSION UNITS	SCALE				
		ANGULAR TOL ±	MM	1:1				
4 PLACES ±	DRWN BY	DATE	MMATLA	2016/06/23				
3 PLACES ±	CHK'D BY	DATE						
2 PLACES ±	APPR BY	DATE	MIWASIECZKO	2016/08/22	PRODUCT CUSTOMER DRAWING			
1 PLACE ±					SERIES	MATERIAL NUMBER	CUSTOMER	
0 PLACES ±					120065	SEE MATRIX (SH 2)		
DRAFT WHERE APPLICABLE MUST REMAIN WITHIN DIMENSIONS		DRAWING SIZE	THIRD ANGLE PROJECTION					
A	REV	A3		DOCUMENT NUMBER		DOC TYPE	DOC PART	SHEET NUMBER
				1200659548		PSD	00P	3 OF 4

88X032B30MXXXXX		
MOLEX PN	ENGINEERING No	CABLE LENGTH [mm]
1200668918	883032B30M006	600
1200668919	883032B30M010	1000
1200668920	883032B30M020	2000
1200668921	883032B30M030	3000
1200668922	883032B30M050	5000
1200668923	883032B30M100	10000
1200668924	884032B30M006	600
1200668925	884032B30M010	1000
1200668926	884032B30M020	2000
1200668927	884032B30M030	3000
1200668928	884032B30M050	5000
1200668929	884032B30M100	10000
1200669003	885032B30M006	600
1200669004	885032B30M010	1000
1200669005	885032B30M020	2000
1200669006	885032B30M030	3000
1200669007	885032B30M050	5000
1200669008	885032B30M100	10000
88X032B36MXXXXX		
MOLEX PN	ENGINEERING No	CABLE LENGTH [mm]
1200669075	884032B36M0057Y	500
1200669076	884032B36M0107Y	1000
1200669077	884032B36M0157Y	1500
1200669078	884032B36M0207Y	2000
1200669079	884032B36M0307Y	3000
1200669080	884032B36M0407Y	4000
1200669081	884032B36M0507Y	5000
1200669082	884032B36M0607Y	6000
1200669083	884032B36M0807Y	8000
1200669084	884032B36M1007Y	10000
1200669085	884032B36M1207Y	12000
1200669086	884032B36M1507Y	15000
1200669087	884032B36M2007Y	20000
1200669088	884032B36M2507Y	25000
1200669089	884032B36M3007Y	30000
1200669090	885032B36M0057Y	500
1200669091	885032B36M0107Y	1000
1200669092	885032B36M0207Y	2000
1200669093	885032B36M0307Y	3000
1200669094	885032B36M0407Y	4000
1200669095	885032B36M0507Y	5000
1200669096	885032B36M0607Y	6000
1200669097	885032B36M0807Y	8000
1200669098	885032B36M1007Y	10000
1200669099	885032B36M1207Y	12000
1200669100	885032B36M1507Y	15000
1200669101	885032B36M1807Y	18000
1200669102	885032B36M2007Y	20000
1200669103	885032B36M2507Y	25000
1200669104	885032B36M3007Y	30000

RELEASE STATUS	P1	RELEASE DATE	22.08.2016	11:01:26
----------------	----	--------------	------------	----------

88X032B41MXXXXX		
MOLEX PN	ENGINEERING No	CABLE LENGTH [mm]
1200668936	888032B41M006	600
1200668937	888032B41M010	1000
1200668938	888032B41M020	2000
1200668939	888032B41M030	3000
1200668940	888032B41M050	5000
1200668941	888032B41M100	10000

88X032B42MXXXXX		
MOLEX PN	ENGINEERING No	CABLE LENGTH [mm]
1200668930	885032B42M006	600
1200668931	885032B42M010	1000
1200668932	885032B42M020	2000
1200668933	885032B42M030	3000
1200668934	885032B42M050	5000
1200668935	885032B42M100	10000

88X033B30MXXXXX		
MOLEX PN	ENGINEERING No	CABLE LENGTH [mm]
1200668942	883033B30M006	600
1200668943	883033B30M010	1000
1200668944	883033B30M020	2000
1200668945	883033B30M030	3000
1200668946	883033B30M050	5000
1200668947	883033B30M100	10000
1200668948	884033B30M006	600
1200668949	884033B30M010	1000
1200668950	884033B30M020	2000
1200668951	884033B30M030	3000
1200668952	884033B30M050	5000
1200668953	884033B30M100	10000
1200669009	885033B30M006	600
1200669010	885033B30M010	1000
1200669011	885033B30M020	2000
1200669012	885033B30M030	3000
1200669013	885033B30M050	5000
1200669014	885033B30M100	10000
1200669259	883033B30M004	400

88X033B41MXXXXX		
MOLEX PN	ENGINEERING No	CABLE LENGTH [mm]
1200668960	888033B41M006	600
1200668961	888033B41M010	1000
1200668962	888033B41M020	2000
1200668963	888033B41M030	3000
1200668964	888033B41M050	5000
1200668965	888033B41M100	10000

88X033B42MXXXXX		
MOLEX PN	ENGINEERING No	CABLE LENGTH [mm]
1200668954	885033B42M006	600
1200668955	885033B42M010	1000
1200668956	885033B42M020	2000
1200668957	885033B42M030	3000
1200668958	885033B42M050	5000
1200668959	885033B42M100	10000

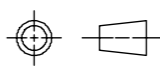
THIS DRAWING CONTAINS INFORMATION THAT IS PROPRIETARY TO MOLEX ELECTRONIC TECHNOLOGIES, LLC AND SHOULD NOT BE USED WITHOUT WRITTEN PERMISSION											
EC NO: 107719 DRWN: MMATLA CHK'D: MIWASIECZKO APPR: MIWASIECZKO	2016/06/23 2016/08/22	GENERAL TOLERANCES (UNLESS SPECIFIED)		DIMENSION UNITS	SCALE						
		ANGULAR TOL ± °		MM	1:1						
		4 PLACES ±		DRWN BY	DATE						
		3 PLACES ±		MMATLA	2016/06/23	CSE M12 XP AC FE XXX TPU MA XXX XM DE					
		2 PLACES ±		CHK'D BY	DATE						
		1 PLACE ±		MIWASIECZKO	2016/08/22	PRODUCT CUSTOMER DRAWING					
		0 PLACES ±		APPR BY	DATE	SERIES	MATERIAL NUMBER	CUSTOMER			
		DRAFT WHERE APPLICABLE MUST REMAIN WITHIN DIMENSIONS		DRAWING SIZE	THIRD ANGLE PROJECTION	120065	SEE MATRIX (SH2)				
				A3		DOCUMENT NUMBER		DOC TYPE	DOC PART	SHEET NUMBER	
						1200659548		PSD	00P	4 OF 4	