



GaAs INTEGRATED CIRCUIT

μ PG2409TB

HIGH POWER SPDT SWITCH FOR WiMAX™

DESCRIPTION

The μ PG2409TB is a GaAs MMIC high power SPDT (Single Pole Double Throw) switch which were designed for WiMAX.

This device can operate frequency from 0.5 to 3.8 GHz, having the low insertion loss and high isolation.

This device is housed in a 6-pin super minimold package (SC-88/SOT-363 type). And this package is suitable for high-density surface mounting.

FEATURES

- Switch control voltage : $V_{\text{cont (H)}} = 3.0 \text{ V TYP.}$
: $V_{\text{cont (L)}} = 0 \text{ V TYP.}$
- Low insertion loss : $L_{\text{ins}} = 0.35 \text{ dB TYP. @ } f = 1.0 \text{ GHz}$
: $L_{\text{ins}} = 0.45 \text{ dB TYP. @ } f = 2.5 \text{ GHz}$
: $L_{\text{ins}} = 0.50 \text{ dB TYP. @ } f = 3.0 \text{ GHz}$
- High isolation : $ISL = 32 \text{ dB TYP. @ } f = 1.0 \text{ GHz}$
: $ISL = 26 \text{ dB TYP. @ } f = 2.5 \text{ GHz}$
: $ISL = 23 \text{ dB TYP. @ } f = 3.0 \text{ GHz}$
- Handling power : $P_{\text{in (1 dB)}} = +35.0 \text{ dBm TYP. @ } f = 0.5 \text{ to } 3.8 \text{ GHz}$
- High-density surface mounting : 6-pin super minimold package (SC-88/SOT-363 type) (2.0 × 1.25 × 0.9 mm)

APPLICATIONS

- WiMAX and wireless LAN (IEEE802.11b/g/n)

ORDERING INFORMATION

Part Number	Order Number	Package	Marking	Supplying Form
μ PG2409TB-E4	μ PG2409TB-E4-A	6-pin super minimold (SC-88/SOT-363 type) (Pb-Free)	G5T	<ul style="list-style-type: none">• Embossed tape 8 mm wide• Pin 4, 5, 6 face the perforation side of the tape• Qty 3 kpcs/reel

Remark To order evaluation samples, please contact your nearby sales office.

Part number for sample order: μ PG2409TB-A

Caution Although this device is designed to be as robust as possible, ESD (Electrostatic Discharge) can damage this device. This device must be protected at all times from ESD. Static charges may easily produce potentials of several kilovolts on the human body or equipment, which can discharge without detection. Industry-standard ESD precautions must be employed at all times.

The information in this document is subject to change without notice. Before using this document, please confirm that this is the latest version.

PIN CONNECTIONS AND INTERNAL BLOCK DIAGRAM

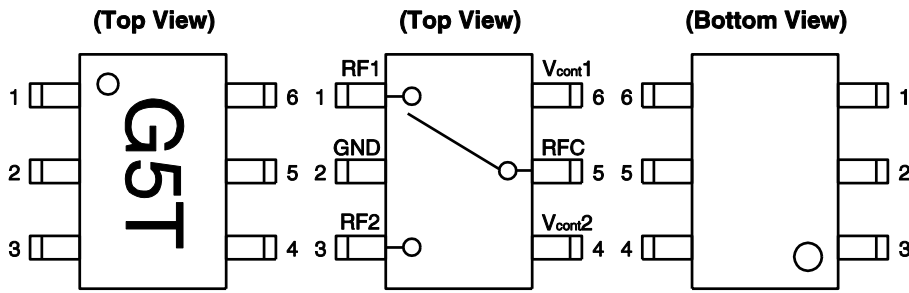

Pin No.	Pin Name
1	RF1
2	GND
3	RF2
4	V _{cont2}
5	RFC
6	V _{cont1}

SW TRUTH TABLE

On Path	V _{cont1}	V _{cont2}
RFC-RF1	High	Low
RFC-RF2	Low	High

ABSOLUTE MAXIMUM RATINGS (T_A = +25°C, unless otherwise specified)

Parameter	Symbol	Ratings	Unit	
Switch Control Voltage	V _{cont}	+6.0 ^{Note}	V	
Input Power	V _{cont} = 3 V	P _{in}	+35	dBm
	V _{cont} = 5 V	P _{in}	+37	
Power Dissipation (average)	P _D	150	mW	
Operating Ambient Temperature	T _A	-45 to +85	°C	
Storage Temperature	T _{stg}	-55 to +150	°C	

Note |V_{cont1} - V_{cont2}| ≤ 6.0 V

RECOMMENDED OPERATING RANGE (T_A = +25°C, unless otherwise specified)

Parameter	Symbol	MIN.	TYP.	MAX.	Unit
Operating Frequency	f	0.5	-	3.8	GHz
Switch Control Voltage (H)	V _{cont (H)}	2.7	3.0	5.3	V
Switch Control Voltage (L)	V _{cont (L)}	-0.2	0	0.2	V
Control Voltage Difference	ΔV _{cont (H)} , ΔV _{cont (L)} ^{Note}	-0.1	0	0.1	V

Note ΔV_{cont (H)} = V_{cont1 (H)} - V_{cont2 (H)}
 ΔV_{cont (L)} = V_{cont1 (L)} - V_{cont2 (L)}

ELECTRICAL CHARACTERISTICS

(T_A = +25°C, V_{cont} (H) = 3.0 V, V_{cont} (L) = 0 V, Z_o = 50 Ω, DC blocking capacitors = 8 pF, unless otherwise specified)

Parameter	Symbol	Test Conditions	MIN.	TYP.	MAX.	Unit
Insertion Loss 1	L _{ins} 1	f = 0.5 to 1.0 GHz ^{Note 1}	–	0.35	0.60	dB
Insertion Loss 2	L _{ins} 2	f = 1.0 to 2.0 GHz ^{Note 1}	–	0.40	0.65	dB
Insertion Loss 3	L _{ins} 3	f = 2.0 to 2.5 GHz	–	0.45	0.70	dB
Insertion Loss 4	L _{ins} 4	f = 2.5 to 3.0 GHz	–	0.50	0.75	dB
Insertion Loss 5	L _{ins} 5	f = 3.0 to 3.8 GHz	–	0.60	0.85	dB
Isolation 1	ISL1	f = 0.5 to 1.0 GHz ^{Note 1}	29	32	–	dB
Isolation 2	ISL2	f = 1.0 to 2.0 GHz ^{Note 1}	25	28	–	dB
Isolation 3	ISL3	f = 2.0 to 2.5 GHz	23	26	–	dB
Isolation 4	ISL4	f = 2.5 to 3.0 GHz	20	23	–	dB
Isolation 5	ISL5	f = 3.0 to 3.8 GHz	16	19	–	dB
Return Loss	RL	f = 0.5 to 3.8 GHz ^{Note 1}	15	20	–	dB
0.1 dB Loss Compression Input Power ^{Note 2}	P _{in} (0.1 dB)	f = 2.5 GHz	–	+33.5	–	dBm
1 dB Loss Compression Input Power 1 ^{Note 3}	P _{in} (1 dB) 1	f = 0.5 to 3.8 GHz ^{Note 1} V _{cont} = 3 V	–	+35	–	dBm
1 dB Loss Compression Input Power 2 ^{Note 3}	P _{in} (1 dB) 2	f = 0.5 to 3.8 GHz ^{Note 1} V _{cont} = 5 V	–	+37	–	dBm
2nd Harmonics	2f ₀	f = 2.5 GHz, P _{in} = +26 dBm	–	75	–	dBc
3rd Harmonics	3f ₀	f = 2.5 GHz, P _{in} = +26 dBm	–	80	–	dBc
Input 3rd Order Intercept Point	IIP ₃	f = 2.5 GHz	–	+60	–	dBm
Switch Control Current	I _{cont}	No RF input	–	0.1	10	μA
Switch Control Speed	t _{sw}	50% CTL to 90/10% RF	–	100	250	ns

Notes 1. DC blocking capacitors = 56 pF at f = 0.5 to 2.0 GHz

2. P_{in} (0.1 dB) is the measured input power level when the insertion loss increases 0.1 dB more than that of the linear range.

3. P_{in} (1 dB) is the measured input power level when the insertion loss increases 1 dB more than that of the linear range.

Caution It is necessary to use DC blocking capacitors with this device.

EVALUATION CIRCUIT

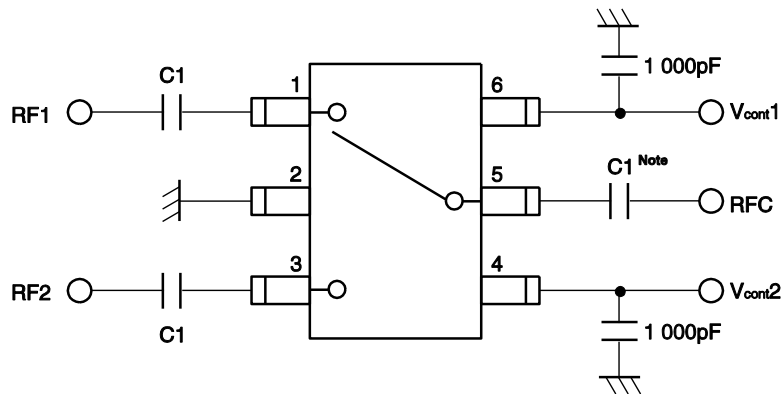

Note C1 : 0.5 to 2.0 GHz 56 pF
 : 2.0 to 3.8 GHz 8 pF

The application circuits and their parameters are for reference only and are not intended for use in actual design-ins.

APPLICATION INFORMATION

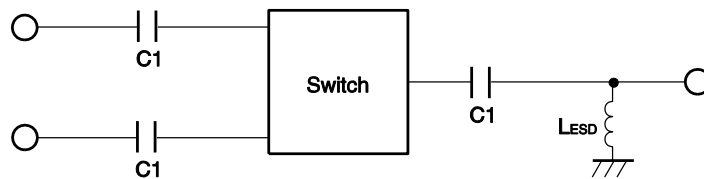

- C1 are DC blocking capacitors external to the device.
 The value may be tailored to provide specific electrical responses.
- The RF ground connections should be kept as short as possible and connected to directly to a good RF ground for best performance.
- L_{ESD} provides a means to increase the ESD protection on a specific RF port, typically the port attached to the antenna.

TYPICAL CHARACTERISTICS

($T_A = +25^\circ\text{C}$, $V_{\text{cont}}(\text{H}) = 2.7$ to 5.3 V, $V_{\text{cont}}(\text{L}) = -0.2$ to 0.2V , unless otherwise specified)

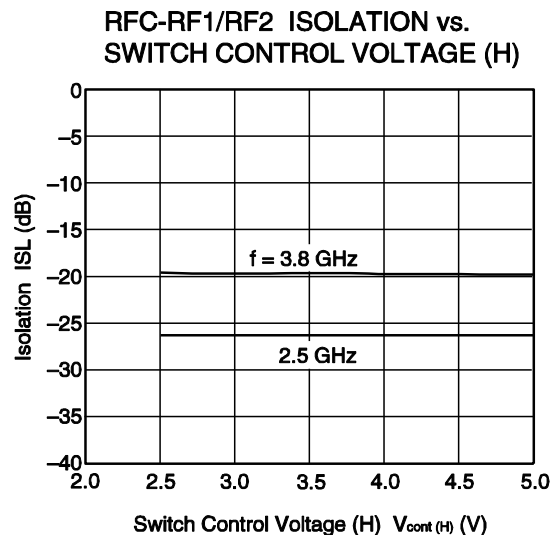
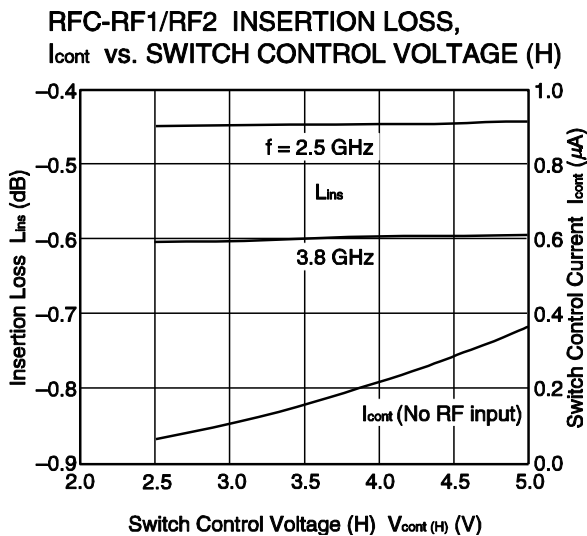
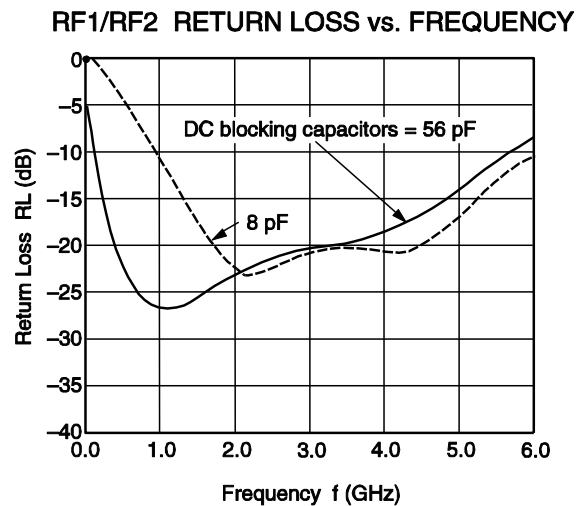
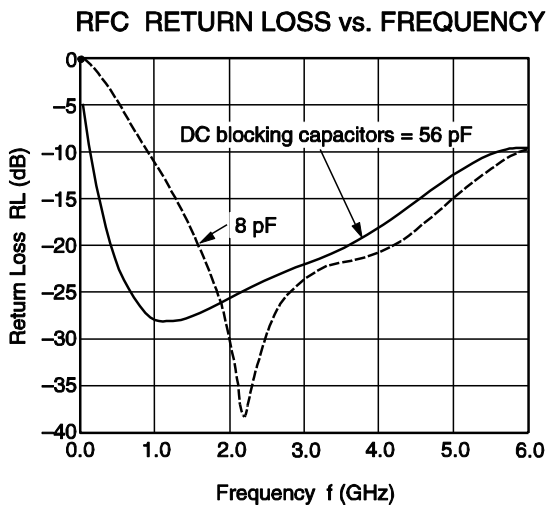
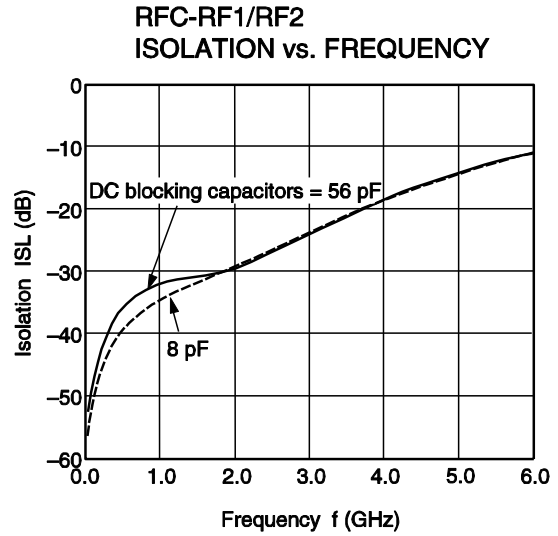
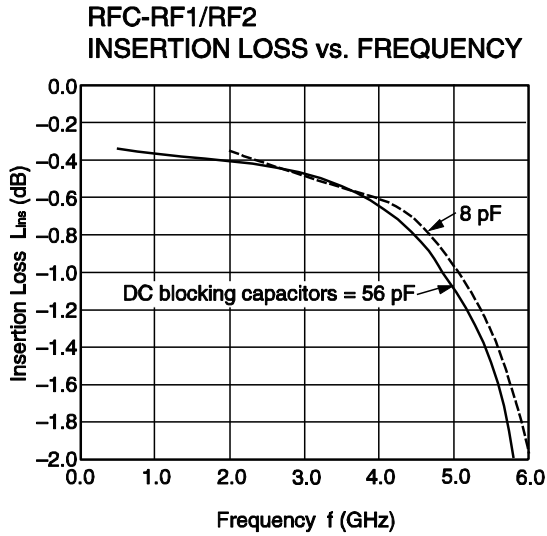

Remark The graphs indicate nominal characteristics.

RFC RETURN LOSS vs. SWITCH CONTROL VOLTAGE (H)

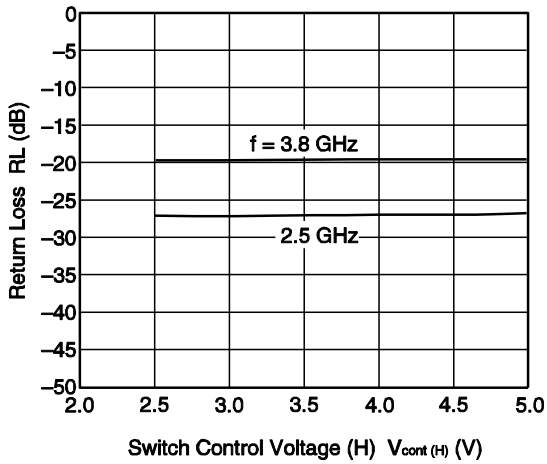

RF1/RF2 RETURN LOSS vs. SWITCH CONTROL VOLTAGE (H)

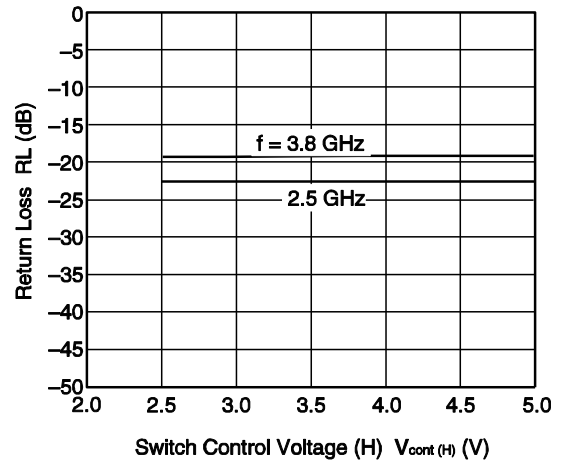

RFC-RF1/RF2 INSERTION LOSS, I_{cont} vs. INPUT POWER

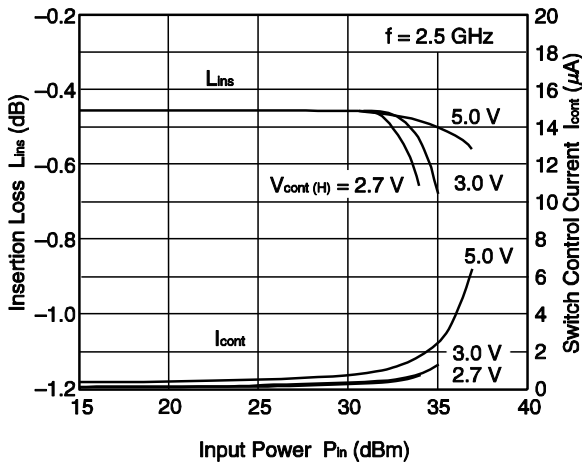

RFC-RF1/RF2 $P_{in(0.1 dB)}$ vs. SWITCH CONTROL VOLTAGE (H)

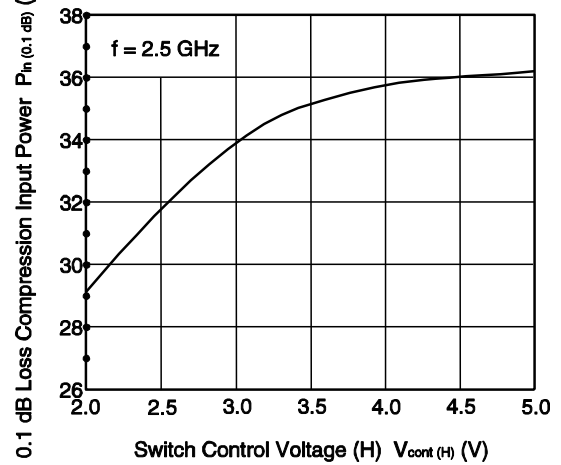

RFC-RF1/RF2 $2f_0, 3f_0$ vs. INPUT POWER

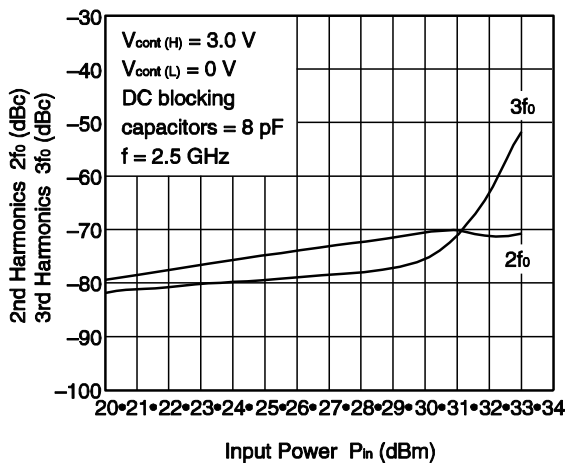

RFC-RF1/RF2 OUTPUT POWER, IM_3 vs. INPUT POWER

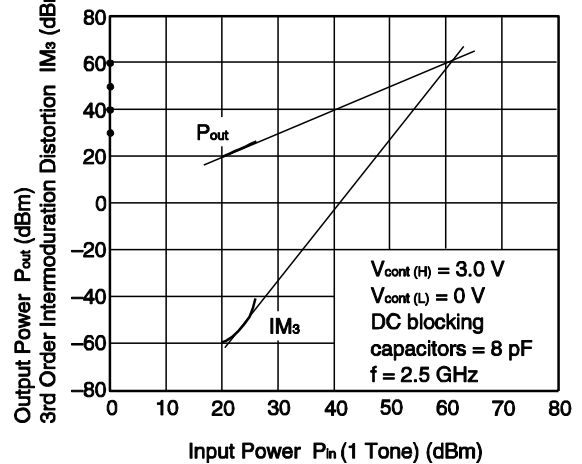

Remark The graphs indicate nominal characteristics.

MOUNTING PAD LAYOUT DIMENSIONS

6-PIN SUPER MINIMOLD (SC-88/SOT-363 type) (UNIT: mm)

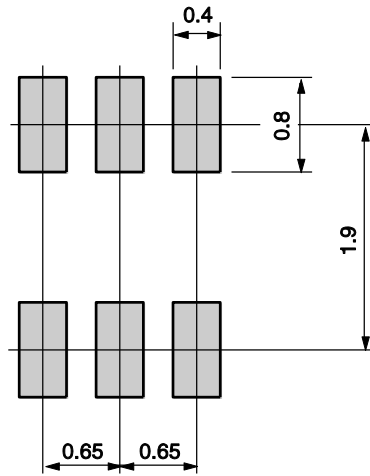

Remark The mounting pad layout in this document is for reference only.
 When designing PCB, please consider workability of mounting, solder joint reliability, prevention of solder bridge and so on, in order to optimize the design.

PACKAGE DIMENSIONS

6-PIN SUPER MINIMOLD (SC-88/SOT-363 type) (UNIT: mm)

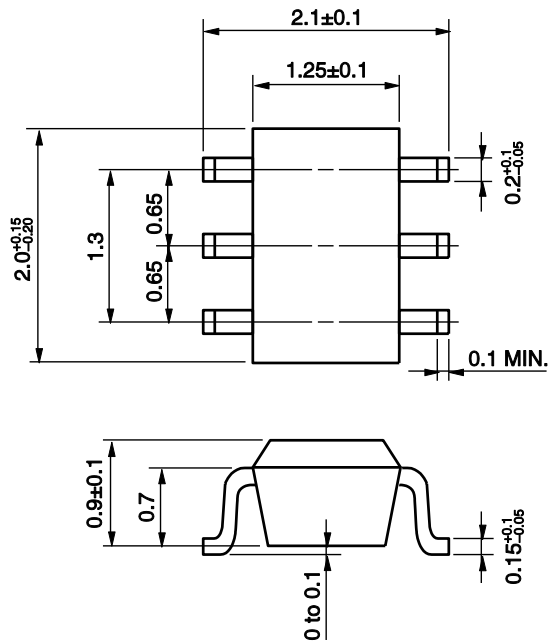

RECOMMENDED SOLDERING CONDITIONS

This product should be soldered and mounted under the following recommended conditions. For soldering methods and conditions other than those recommended below, contact your nearby sales office.

Soldering Method	Soldering Conditions	Condition Symbol
Infrared Reflow	Peak temperature (package surface temperature) : 260°C or below Time at peak temperature : 10 seconds or less Time at temperature of 220°C or higher : 60 seconds or less Preheating time at 120 to 180°C : 120±30 seconds Maximum number of reflow processes : 3 times Maximum chlorine content of rosin flux (% mass) : 0.2%(Wt.) or below	IR260
Wave Soldering	Peak temperature (molten solder temperature) : 260°C or below Time at peak temperature : 10 seconds or less Preheating temperature (package surface temperature) : 120°C or below Maximum number of flow processes : 1 time Maximum chlorine content of rosin flux (% mass) : 0.2%(Wt.) or below	WS260
Partial Heating	Peak temperature (terminal temperature) : 350°C or below Soldering time (per side of device) : 3 seconds or less Maximum chlorine content of rosin flux (% mass) : 0.2%(Wt.) or below	HS350

Caution Do not use different soldering methods together (except for partial heating).

<p>Caution GaAs Products</p>	<p>This product uses gallium arsenide (GaAs). GaAs vapor and powder are hazardous to human health if inhaled or ingested, so please observe the following points.</p> <ul style="list-style-type: none"> • Follow related laws and ordinances when disposing of the product. If there are no applicable laws and/or ordinances, dispose of the product as recommended below. <ol style="list-style-type: none"> 1. Commission a disposal company able to (with a license to) collect, transport and dispose of materials that contain arsenic and other such industrial waste materials. 2. Exclude the product from general industrial waste and household garbage, and ensure that the product is controlled (as industrial waste subject to special control) up until final disposal. <ul style="list-style-type: none"> • Do not burn, destroy, cut, crush, or chemically dissolve the product. • Do not lick the product or in any way allow it to enter the mouth.
-------------------------------------	---