

Mating figure

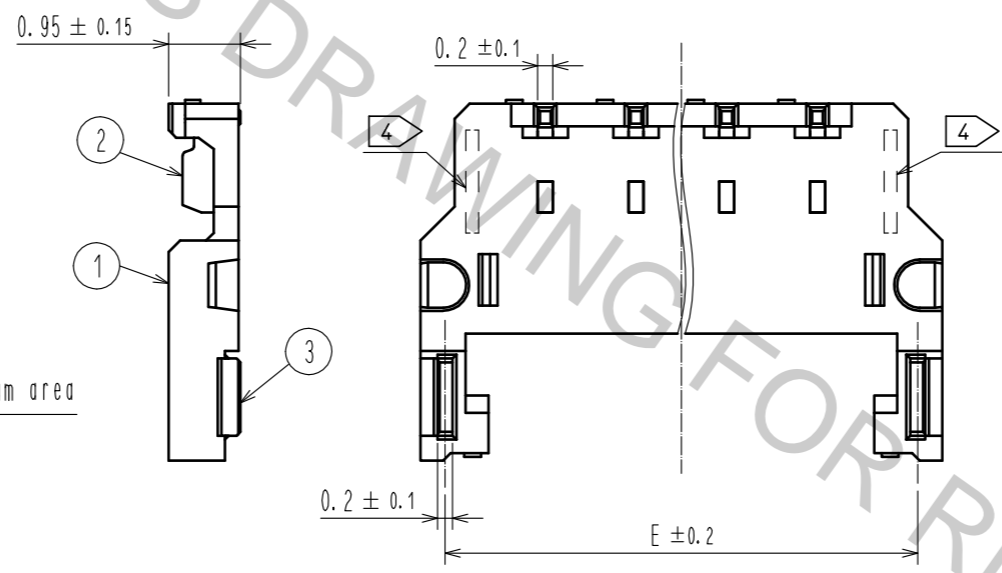

Recommended PCB layout
Recommended metal mask (Thickness : 0.1mm)

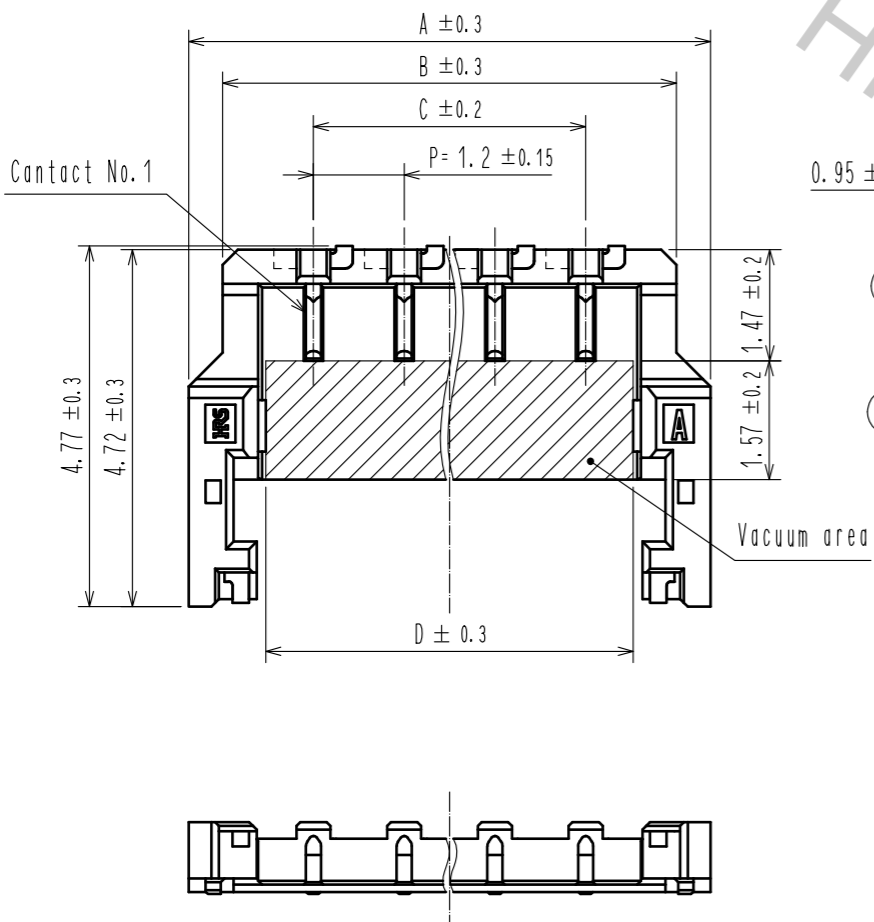
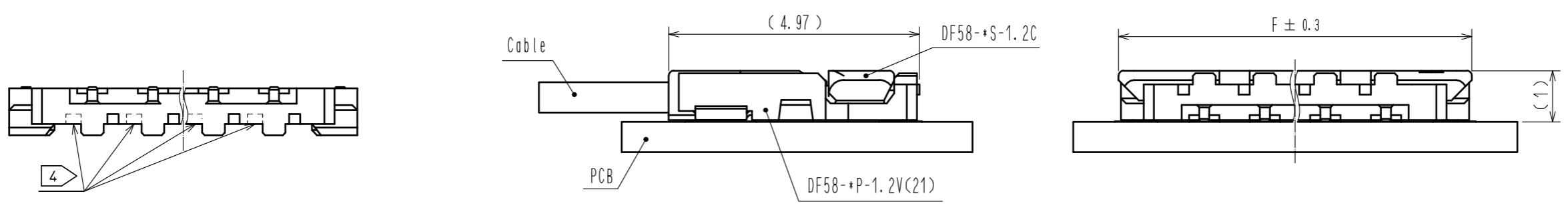
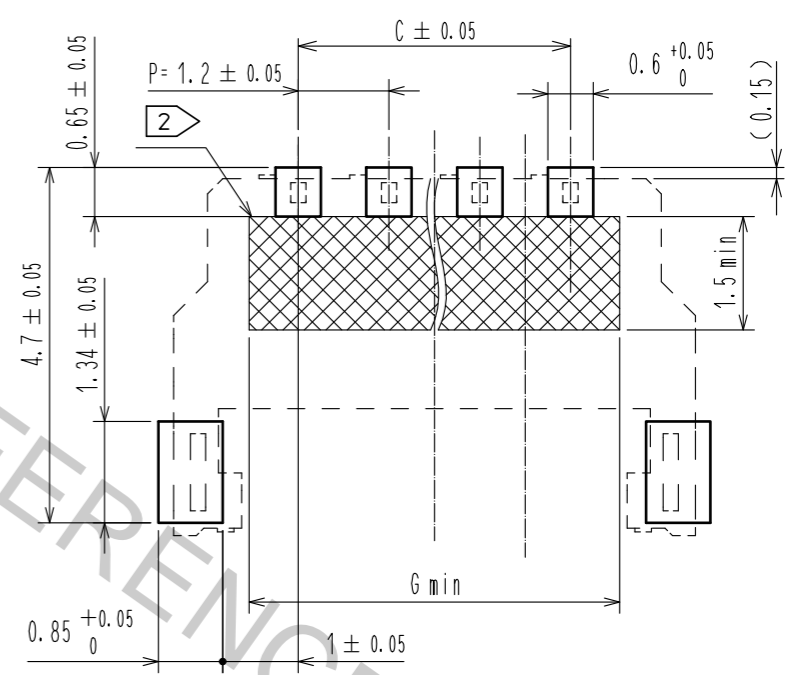

CODE No.	PART No.	NUMBER OF CONTACTS	A	B	C	D	E	F	G
CL666-1001-0-00	DF58-2P-1.2V(21)	2	4.5	3.6	1.2	2.4	3.85	4.6	2.5
CL666-1002-0-00	DF58-3P-1.2V(21)	3	5.7	4.8	2.4	3.6	5.05	5.8	3.7
CL666-1003-0-00	DF58-4P-1.2V(21)	4	6.9	6.0	3.6	4.8	6.25	7.0	4.9
CL666-1005-0-00	DF58-6P-1.2V(21)	6	9.3	8.4	6.0	7.2	8.65	9.4	7.3

- Notes
- Lead co-planarity shall be 0.1mm MAX.
 - area indicated must be free of conductive traces or the conductive traces must be covered by resist film.
 - Please consult Hirose when the product is mounted to FPC.
 - Only for DF58-6P-1.2V(##), lightening hole in the indicated area.

3	Copper alloy	Surface : Tin plating 1 μm MIN Under plating : Nickel plating 0.5 μm MIN				
2	Copper alloy	Surface : Tin plating 1 μm MIN Under plating : Nickel plating 0.5 μm MIN	6	PS	Reel . Black	
			5	Polyester	Clear [Cover tape]	
1	LCP	UL94V-0, Black	4	PS	Clear [Embossed carrier tape]	
NO.	MATERIAL	FINISH . REMARKS	NO.	MATERIAL	FINISH . REMARKS	
UNITS		SCALE	COUNT	DESCRIPTION OF REVISIONS		DESIGNED
mm		10 : 1				CHECKED
						DATE
HRS HIROSE ELECTRIC CO., LTD.		APPROVED : HS. OKAWA	16.06.22	DRAWING NO.		EDC-371175-00-00
		CHECKED : YN. TAKASHITA	16.06.21	PART NO.		DF58-*P-1.2V(21)
		DESIGNED : TH. YOSHIZAWA	16.06.21	CODE NO.		CL666-
		DRAWN : TH. YOSHIZAWA	16.06.21			1/3

Drawing for packing (FREE)

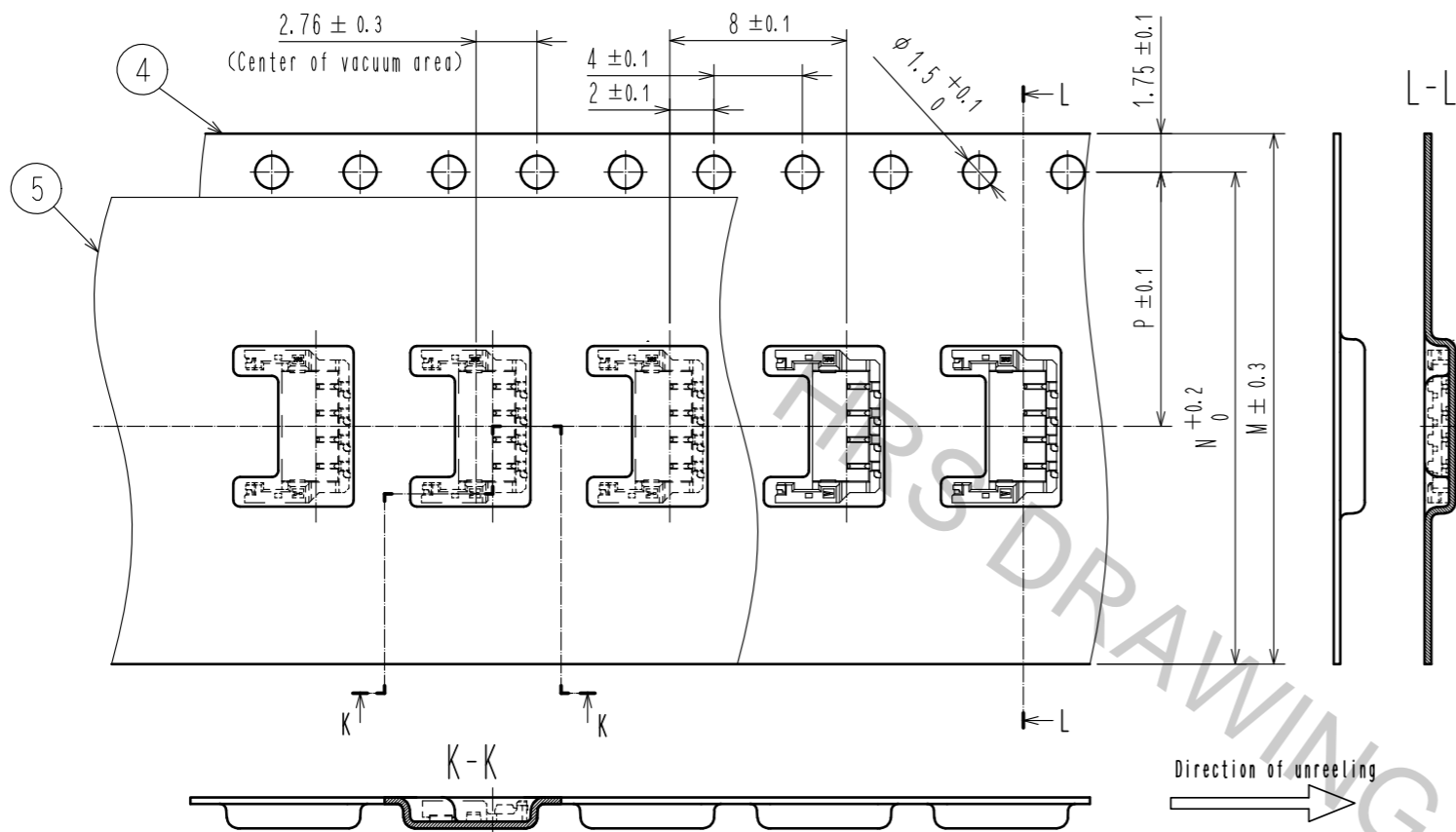

Reflow temperature profile using lead-free solder paste (Reference)

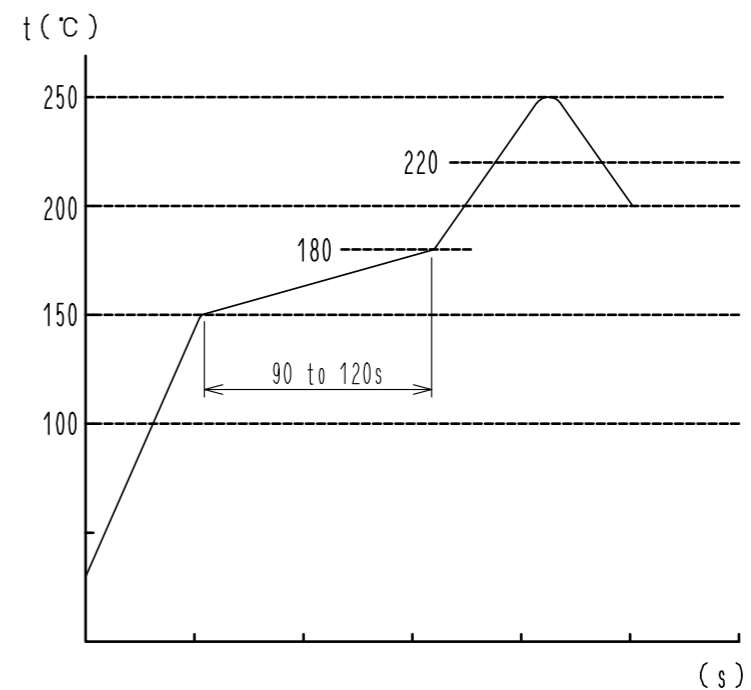

Number of reflow cycles 2 cycles max.
The temperature is measured in the terminal lead part.

Additional factors, such as solder paste type, PCB size and other mounted components could affect the profile, therefore, a thorough evaluation of mounting condition is required prior to production. Temperature is measured at contact lead.

6 TAPING (FREE)

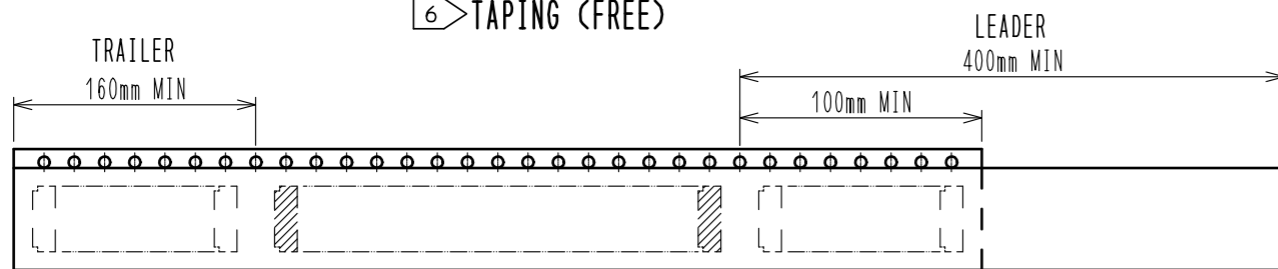

EMPTY COMPONENTS PORTION EQUIPPED WITH CONNECTORS EMPTY COMPONENTS

CODE No.	PART No.	NUMBER OF CONTACTS	M	N	P	Q	R
CL666-1001-0-00	DF58-2P-1.2V(21)	2	16.0	14.25	7.5	22.4	16.4
CL666-1002-0-00	DF58-3P-1.2V(21)	3	16.0	14.25	7.5	22.4	16.4
CL666-1003-0-00	DF58-4P-1.2V(21)	4	24.0	22.25	11.5	30.4	24.4
CL666-1005-0-00	DF58-6P-1.2V(21)	6	24.0	22.25	11.5	30.4	24.4

NOTES 5. 1 reel : 6000 connectors
6 Reel to JIS C 0806. (Packaging of components for automatic handling)
7. The dimensions in parentheses are for reference.

Style and dimension of reel (Free)

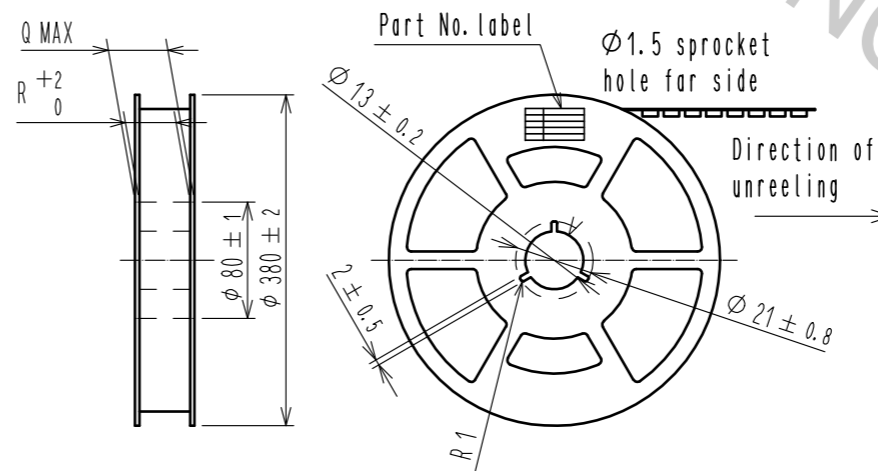

Detail of part No. label

生産月日	年 月 日
図 番	CL666-****-21
品 名	DF58-*P-1.2V(21)
納入数量	6000 KO
納入者	ヒロセ電機(株)

Supplier
Quantity
Part No.
Code No.
Date of manufactured

HRS	DRAWING NO.	EDC-371175-00-00
	PART NO.	DF58-*P-1.2V(21)
	CODE NO.	CL666-

DF58 Series Mating / Unmating Operation Instruction

Mating

① By positioning the convexity of the socket sides to the header concavity, align the centers of the socket and the header in pitch direction.

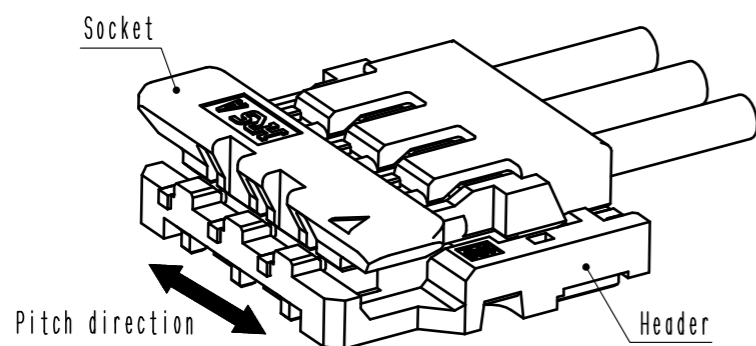

② Slightly press the socket down at the center of the socket.

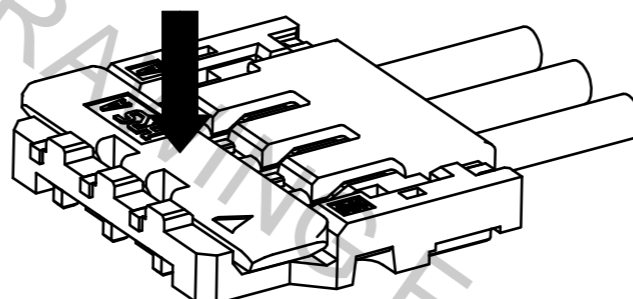

③ Press down at the lever side with stabilizing the cable side to insert. Mating completes.

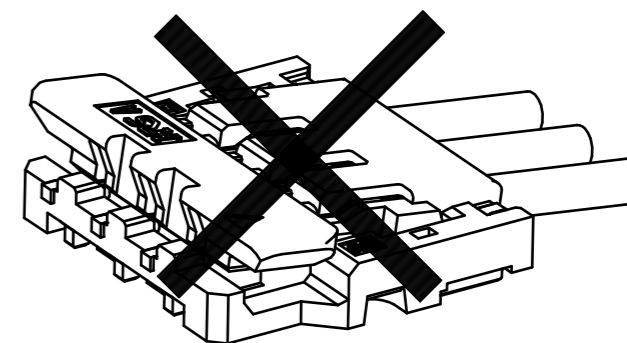

Unmating

① Hook the lever with finger nail. (Possible with one side)

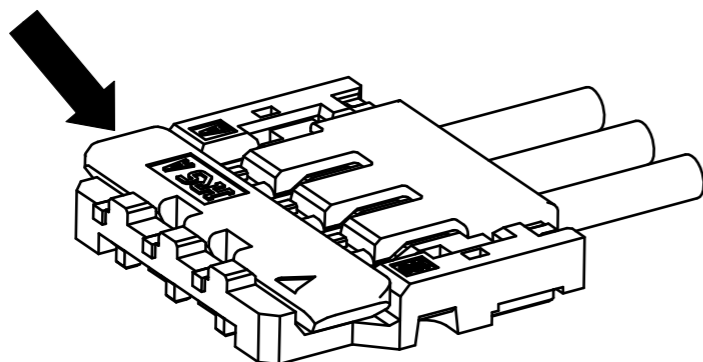

② Lift up to the upper direction and friction lock is released.

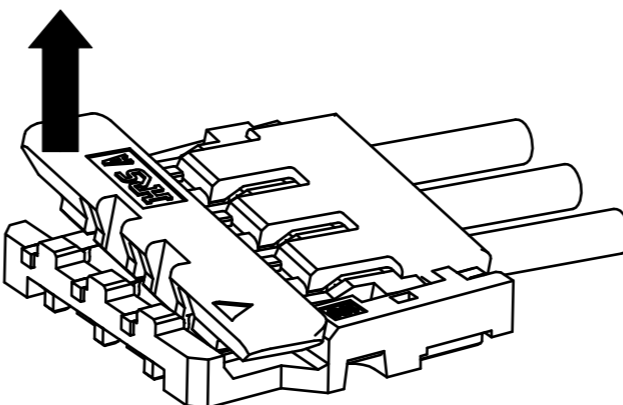

③ Lift it up to the upper direction more. and removal completes.

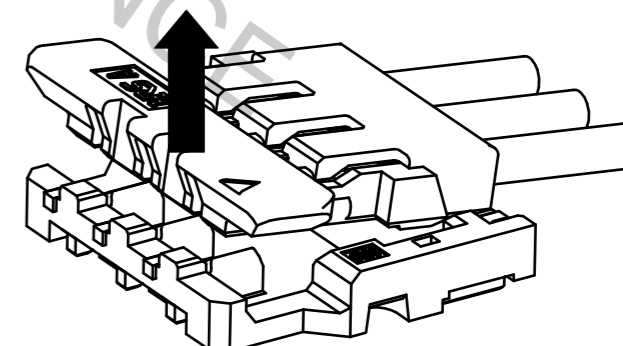

HRS	DRAWING NO.	EDC-371175-00-00
	PART NO.	DF58-*P-1.2V(21)
	CODE NO.	CL666-
		3/3

Apr.1.2017 Copyright 2017 HIROSE ELECTRIC CO., LTD. All Rights Reserved.